

[Home](#)[safety and
troubleshooting](#)[about this
manual](#)[product
information](#)[installing your
monitor](#)[on-screen
display](#)[customer care
and warranty](#)[glossary](#)[download
& print](#)

LCD Monitor

200BW8



- Safety Precautions and Maintenance
- Installation Locations
- FAQs
- Troubleshooting
- Regulatory Information
- Other Related Information

Safety and Troubleshooting Information

Safety precautions and maintenance



WARNING: Use of controls, adjustments or procedures other than those specified in this documentation may result in exposure to shock, electrical hazards and/or mechanical hazards.

Read and follow these instructions when connecting and using your computer monitor:

- To protect your display from possible damage, do not put excessive pressure on the LCD panel. When moving your monitor, grasp the frame to lift; do not lift the monitor by placing your hand or fingers on the LCD panel.
- Unplug the monitor if you are not going to use it for an extensive period of time.
- Unplug the monitor if you need to clean it with a slightly damp cloth. The screen may be wiped with a dry cloth when the power is off. However, never use alcohol, solvents or ammonia-based liquids.
- Consult a service technician if the monitor does not operate normally when you have followed the instructions in this manual.
- The casing cover should be opened only by qualified service personnel.
- Keep the monitor out of direct sunlight and away from stoves or any other heat source.
- Remove any object that could fall into the vents or prevent proper cooling of the monitor's electronics.
- Do not block the ventilation holes on the cabinet.
- Keep the monitor dry. To avoid electric shock, do not expose it to rain or excessive moisture.
- When positioning the monitor, make sure the power plug and outlet are easily accessible.
- If turning off the monitor by detaching the power cable or DC power cord, wait for 6 seconds before attaching the power cable or DC power cord for normal operation.
- To avoid the risk of shock or permanent damage to the set, do not expose the monitor to rain or excessive moisture.
- **IMPORTANT:** Always activate a screen saver program during your application. If a still image in high contrast remains on the screen for an extended period of time, it may leave an 'after-image' or 'ghost image' on front of the screen. This is a well-known phenomenon that is caused by the shortcomings inherent in LCD technology. In most cases, the afterimage will disappear gradually over a period of time after the power has been switched off. Be aware, that the afterimage symptom cannot be repaired and is not covered under warranty.
- Warning for lifting monitor - Do not use the area underneath the logo cover to grip or lift the monitor. Placing weight on the logo cover can cause it to break away from the body and cause the monitor to fall. When lifting the monitor, place one hand under the monitor's frame.

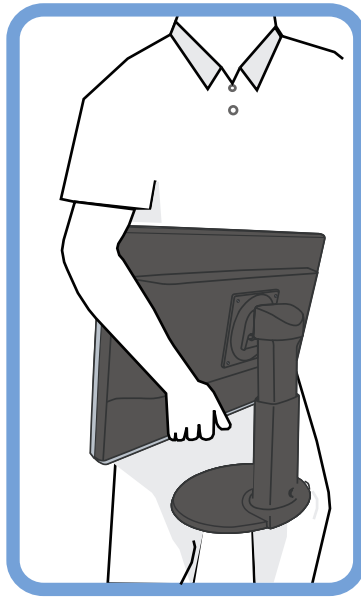

O Do



X Don't

Consult a service technician if the monitor does not operate normally when the operating instructions given in this manual have been followed.

[RETURN TO TOP OF THE PAGE](#)

Installation Locations

- Avoid exposure to heat and extreme cold.
- Do not store or use the LCD monitor in locations exposed to heat, direct sunlight or extreme cold.
- Avoid moving the LCD monitor between locations with large temperature differences. Choose a site that falls within the following temperature and humidity ranges.
 - Temperature: 0-35°C 32-95°F
 - Humidity: 20-80% RH
- Do not subject the LCD monitor to severe vibration or high impact conditions. Do not place the LCD monitor in the trunk of a car.
- Take care not to mishandle this product by either knocking or dropping it during operation or transportation.
- Do not store or use the LCD monitor in locations where there is a high level of humidity or in dusty environments. Do not allow water or other liquids to spill on or into the LCD monitor.

[RETURN TO TOP OF THE PAGE](#)

- Safety and Troubleshooting
- General FAQs
- Screen Adjustments
- Compatibility with Other Peripherals
- LCD Panel Technology
- Ergonomics, Ecology and Safety Standards
- Troubleshooting
- Regulatory Information
- Other Related Information

FAQs (Frequently Asked Questions)

General FAQs

Q: When I install my monitor what should I do if the screen shows 'Cannot display this video mode'?

A: Recommended video mode for Philips 20": 1680x1050 @60Hz.

1. Unplug all cables, then connect your PC to the monitor that you used previously.
 2. In the Windows Start Menu, select Settings/Control Panel. In the Control Panel Window, select the Display icon. Inside the Display Control Panel, select the 'Settings' tab. Under the setting tab, in box labeled 'desktop area', move the slider to 1680x1050 pixels (20").
 3. Open 'Advanced Properties' and set the Refresh Rate to 60Hz, then click OK.
 4. Restart your computer and repeat step 2 and 3 to verify that your PC is set at 1680x1050@60Hz (20").
 5. Shut down your computer, disconnect your old monitor and reconnect your Philips LCD monitor.
 6. Turn on your monitor and then turn on your PC.
-

Q: What does 'refresh rate' mean in connection with an LCD monitor?

A: The refresh rate is of much less relevance for LCD monitors. LCD monitors display a stable, flicker-free image at 60Hz. There is no visible difference between 85Hz and 60Hz.

Q: What are the .inf and .icm files on the CD-ROM? How do I install the drivers (.inf and .icm)?

A: These are the driver files for your monitor. Follow the instructions in your user manual to install the drivers. Your computer may ask you for monitor drivers (.inf and .icm files) or a driver disk when you first install your monitor. Follow the instructions to insert the (companion CD-ROM) included in this package. Monitor drivers (.inf and .icm files) will be installed automatically.

Q: How do I adjust the resolution?

A: Your video card/graphic driver and monitor together determine the available resolutions. You can select the desired resolution under Windows® Control Panel with the "Display properties".

Q: What if I get lost when I am making monitor adjustments?

A: Simply press the OK button, then select 'Reset' to recall all of the original factory settings.

Q: What is the Auto function?

A: The *AUTO adjustment* key restores the optimal screen position, phase and clock settings by pressing of a single button – without the need to navigate through OSD (On Screen Display) menus and control keys.

Note: Auto function is available in selected models from D-sub input.

Q: My Monitor has no power (Power LED does not light up). What should I do?

A: Make sure the AC power cord is connected between the monitor and AC outlet, and click a key on keyboard/mouse to wake up the PC.

Q: Will the LCD monitor accept an interlaced signal under PC models?

A: No. If an Interlace signal is used, the screen displays both odd and even horizontal scanning lines at the same time, thus distorting the picture.

Q: What does the Refresh Rate mean for LCD?

A: Unlike CRT display technology, in which the speed of the electron beam is swept from the top to the bottom of the screen determines flicker, an active matrix display uses an active element (TFT) to control each individual pixel and the refresh rate is therefore not really applicable to LCD technology.

Q: Will the LCD screen be resistant to scratches?

A: A protective coating is applied to the surface of the LCD, which is durable to a certain extent (approximately up to the hardness of a 2H pencil). In general, it is recommended that the panel surface is not subject to any excessive shocks or scratches.

Q: How should I clean the LCD surface?

A: For normal cleaning, use a clean, soft cloth. For extensive cleaning, please use isopropyl alcohol. Do not use other solvents such as ethyl alcohol, ethanol, acetone, hexane, etc.

Q: Can I change the color setting of my monitor?

A: Yes, you can change your color setting through OSD control as the following procedures,

1. Press "OK" to show the OSD (On Screen Display) menu
2. Press "Down Arrow" to select the option "color" then press "OK" to enter color setting, there are five settings as below.

- a. Original; this setting load the default panel setting in terms of color tone. (Note: different panel maker may feature a different color temperature*)
- b. 9300K; this setting features the panel closed to blue-white color tone.
- c. 6500K; this setting features the panel closed to red-white color tone.
- d. sRGB; this is a standard setting for ensuring correct exchange of colors between different device (e.g. digital cameras, monitors, printers, scanners, etc.)
- e. User Define; the user can choose his/her preference color setting by adjusting red, green, blue color.

*A measurement of the color of light radiated by an object while it is being heated. This measurement is expressed in terms of absolute scale, (degrees Kelvin). Lower Kevin temperatures such as 2004K are red; higher temperatures such as 9300K are blue. Neutral temperature is white, at 6504K.

Q: Can the Philips LCD Monitor be mounted on the wall?

A: Yes. Philips LCD monitors have this optional feature. Four standard VESA mount holes on the rear cover allows the user to mount the Philips monitor on most of the VESA standard arms or accessories. We recommend to contact your Philips sales representative for more information.

[RETURN TO TOP OF THE PAGE](#)

Screen Adjustments

Q: What is the FPadjust program on the CD-ROM?

A: The FPadjust program generates alignment patterns that help you adjust monitor settings such as Contrast, Brightness, Horizontal Position, Vertical Position, Phase and Clock for optimal performance.

Q: When I install my monitor, how do I get the best performance from the monitor?

A:

1. For best performance, make sure your display settings are set at 1680x1050@60Hz for 20". Note: You can check the current display settings by pressing the OSD OK button once. The current display mode is shown in OSD first page.
2. To install the Flat Panel Adjust (FPadjust) program located on the monitor setup CD-ROM, open the CD-ROM and double-click the FP_setup4.3.exe icon. This will install FP Adjust automatically and place a shortcut on your desktop.
3. Run FPadjust by double clicking the shortcut. Follow the instructions

step by step to optimize image performance with your system's video controller.

Q: How do LCDs compare to CRTs in terms of radiation?

A: Because LCDs do not use an electron gun, they do not generate the same amount of radiation at the screen surface.

[RETURN TO TOP OF THE PAGE](#)

Compatibility with other Peripherals

Q: Can I connect my LCD monitor to any PC, workstation or Mac?

A: Yes. All Philips LCD monitors are fully compatible with standard PCs, Macs and workstations. You may need a cable adapter to connect the monitor to your Mac system. Please contact your dealer/retailer for more information.

Q: Are Philips LCD monitors Plug-and-Play?

A: Yes, the monitors are Plug-and-Play compatible with Windows® 95, 98, 2000, XP and Vista.

Q: My monitor has no picture when connect to DVI-I w/ analog signal on the PC via DVI-D SUB cable after startup PC. What should I do?

A: Try to change to DVI-I w/ digital via DVI cable and re-startup PC. DVI-I standard basically combines both analog and digital in single connector. The monitor also contains two types of analog and digital EDID. Digital EDID will set as the default and analog EDID will automatically change refer to analog signal. This is likely that your PC read EDID type before making decision to send analog or digital from DVI-I port. However, this compatibility limitation is rarely found on PC, workstation, or Mac.

Q: What is USB (Universal Serial Bus)?

A: Think of USB as a smart plug for PC peripherals. USB automatically determines resources (like driver software and bus bandwidth) required by peripherals. USB makes necessary resources available without user intervention. There are three main benefits of USB. USB eliminates "case anxiety," the fear of removing the computer case to install circuit board cards -- that often requires adjustment of complicated IRQ settings -- for add-on peripherals. USB does away with "port gridlock." Without USB, PCs are normally limited to one printer, two Com port devices (usually a mouse and modem), one Enhanced Parallel Port add-on (scanner or video camera, for example), and a joystick. More and more peripherals for multimedia computers come on the market every day. With USB, up to 127 devices can run simultaneously on one computer. USB permits "hot plug-in." No need to shut down, plug in, reboot and run set up to install peripherals. No need to go

through the reverse process to unplug a device. Bottom line: USB transforms today's "Plug-and-Pray" into true Plug-and-Play!

Please refer to glossary for more information about USB.

Q: What is a USB hub ?

A: A USB hub provides additional connections to the Universal Serial Bus. A hub's upstream port connects a hub to the host, usually a PC. Multiple downstream ports in a hub allows connection to another hub or device, such as a USB keyboard, camera or printer.

Q: What can I do if my USB peripherals don't work with the USB hub of my monitor?

A: If you experience the problem, just detach and re-attach the USB hub cable between PC and your monitor, then refresh your PC device manager (Start > Setting > Control panel > System > Hardware > Device manager > Refresh) or reboot your PC and the problem can be solved by above procedures.

[RETURN TO TOP OF THE PAGE](#)

LCD Panel Technology

Q: What is a Liquid Crystal Display?

A: A Liquid Crystal Display (LCD) is an optical device that is commonly used to display ASCII characters and images on digital items such as watches, calculators, portable game consoles, etc. LCD is the technology used for displays in notebooks and other small computers. Like light-emitting diode and gas-plasma technologies, LCD allows displays to be much thinner than cathode ray tube (CRT) technology. LCD consumes much less power than LED and gas-displays because it works on the principle of blocking light rather than emitting it.

Q: What differentiates passive matrix LCDs from active matrix LCDs?

A: An LCD is made with either a passive matrix or an active matrix display grid. An active matrix has a transistor located at each pixel intersection, requiring less current to control the luminance of a pixel. For this reason, the current in an active matrix display can be switched on and off more frequently, improving the screen refresh time (your mouse pointer will appear to move more smoothly across the screen, for example). The passive matrix LCD has a grid of conductors with pixels located at each intersection in the grid.

Q: What are the advantages of TFT LCD compared with CRT?

A: In a CRT monitor, a gun shoots electrons and general light by colliding polarized electrons on fluorescent glass. Therefore, CRT monitors basically operate with an analog RGB signal. A TFT LCD monitor is a device that

displays an input image by operating a liquid crystal panel. The TFT has a fundamentally different structure than a CRT: Each cell has an active matrix structure and independent active elements. A TFT LCD has two glass panels and the space between them is filled with liquid crystal. When each cell is connected with electrodes and impressed with voltage, the molecular structure of the liquid crystal is altered and controls the amount of inlet lighting to display images. A TFT LCD has several advantages over a CRT, since it can be very thin and no flickering occurs because it does not use the scanning method.

Q: Why is vertical frequency of 60Hz optimal for an LCD monitor?

A: Unlike a CRT monitor, the TFT LCD panel has a fixed resolution. For example, an XGA monitor has 1024x3 (R, G, B) x 768 pixels and a higher resolution may not be available without additional software processing. The panel is designed to optimize the display for a 65MHz dot clock, one of the standards for XGA displays. Since the vertical/horizontal frequency for this dot clock is 60Hz/48kHz, the optimum frequency for this monitor is 60Hz.

Q: What kind of wide-angle technology is available? How does it work?

A: The TFT LCD panel is an element that controls/displays the inlet of a backlight using the dual-refraction of a liquid crystal. Using the property that the projection of inlet light refracts toward the major axis of the liquid element, it controls the direction of inlet light and displays it. Since the refraction ratio of inlet light on liquid crystal varies with the inlet angle of the light, the viewing angle of a TFT is much narrower than that of a CRT. Usually, the viewing angle refers to the point where the contrast ratio is 10. Many ways to widen the viewing angle are currently being developed and the most common approach is to use a wide viewing angle film, which widens the viewing angle by varying the refraction ratio. IPS (In Plane Switching) or MVA (Multi Vertical Aligned) is also used to give a wider viewing angle.

Q: Why is there no flicker on an LCD Monitor?

A: Technically speaking, LCDs do flicker, but the cause of the phenomenon is different from that of a CRT monitor -- and it has no impact of the ease of viewing. Flickering in an LCD monitor relates to usually undetectable luminance caused by the difference between positive and negative voltage. On the other hand, CRT flickering that can irritate the human eye occurs when the on/off action of the fluorescent object becomes visible. Since the reaction speed of liquid crystal in an LCD panel is much slower, this troublesome form of flickering is not present in an LCD display.

Q: Why is an LCD monitor virtually low of Electro Magnetic Interference?

A: Unlike a CRT, an LCD monitor does not have key parts that generate Electro Magnetic Interference, especially magnetic fields. Also, since an LCD display utilizes relatively low power, its power supply is extremely quiet.

[RETURN TO TOP OF THE PAGE](#)

Ergonomics, Ecology and Safety Standards

Q: What is the CE mark?

A: The CE (Conformité Européenne) mark is required to be displayed on all regulated products offered for sale on the European market. This 'CE' mark means that a product complies with the relevant European Directive. A European Directive is a European 'Law' that relates to health, safety, environment and consumer protection, much the same as the U.S. National Electrical Code and UL Standards.

Q: Does the LCD monitor conform to general safety standards?

A: Yes. Philips LCD monitors conform to the guidelines of MPR-II and TCO 99/03 standards for the control of radiation, electromagnetic waves, energy reduction, electrical safety in the work environment and recyclability. The specification page provides detailed data on safety standards.

More information is provided in the [Regulatory Information](#) section.

RETURN TO TOP OF THE PAGE

Troubleshooting

- Safety and Troubleshooting
- FAQs
- Common Problems
- Imaging Problems
- Regulatory Information
- Other Related Information

This page deals with problems that can be corrected by the user. If the problem still persists after you have tried these solutions, contact your nearest Philips dealer.

Common Problems

Having this problem

Check these items

No Picture
(Power LED not lit)

- Make sure the power cord is plugged into the power outlet and into the back of the monitor.
- First, ensure that the power button on the front of the monitor is in the OFF position, then press it to the ON position.

No Picture
(Power LED is amber or yellow)

- Make sure the computer is turned on.
- Make sure the signal cable is properly connected to your computer.
- Check to see if the monitor cable has bent pins.
- The Energy Saving feature may be activated

Screen says



- Make sure the monitor cable is properly connected to your computer. (Also refer to the Quick Set-Up Guide).
- Check to see if the monitor cable has bent pins.
- Make sure the computer is turned on.

Screen says

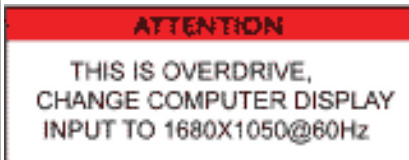

- Make sure the vertical sync of input signal is within the range of 56 ~ 76 Hz.
- Change the refresh rate to 56~76Hz within 10 minutes.
- Re-power on monitor to start over again if you failed to change the refresh rate within 10 minutes.

AUTO button not working properly

- The Auto Function is designed for use on standard Macintosh or IBM-compatible PCs running Microsoft Windows.
- It may not work properly if using nonstandard PC or video card.
- The AUTO adjustment does not function when digital input is used for display.

Imaging Problems

Display position is incorrect

- Press the Auto button.
- Adjust the image position using the Horizontal Position and/or Vertical Position in OSD Main Controls.

Image vibrates on the screen

- Check that the signal cable is properly connected to the graphics board or PC.

Vertical flicker appears



- Press the Auto button.
- Eliminate the vertical bars using the Phase/Clock of More Settings in OSD Main Controls.

Horizontal flicker appears



- Press the Auto button.
- Eliminate the vertical bars using the Phase/Clock of More Settings in OSD Main Controls.

The screen is too bright or too dark

- Adjust the contrast and brightness on OSD Main Controls. (The backlight of the LCD monitor has a fixed life span. When the screen becomes dark or begins to flicker, please contact your dealer).

An after-image appears

- If an image remains on the screen for an extended period of time, it may be imprinted in the screen and leave an after-image. This usually disappears after a few hours

An after-image remains after the power has been turned off.

- This is characteristic of liquid crystal and is not caused by a malfunction or deterioration of the liquid crystal. The after-image will disappear after a period of time.

Green, red, blue, dark, and white dots remains

- **The remaining dots are normal characteristic of the liquid crystal used in today's technology.**

For further assistance, refer to the [Consumer Information Centers](#) list and contact your local Philips distributor.

[RETURN TO TOP OF THE PAGE](#)

- CE Declaration of Conformity
- Energy Star Declaration
- Federal Communications Commission (FCC) Notice (U.S. Only)
- FCC Declaration of Conformity
- Commission Federale de la Communication (FCC Declaration)
- EN 55022 Compliance (Czech Republic Only)
- VCCI Class 2 Notice (Japan Only)
- MIC Notice (South Korea Only)
- Polish Center for Testing and Certification Notice
- North Europe (Nordic Countries) Information
- BSMI Notice (Taiwan Only)
- Ergonomie Hinweis (nur Deutschland)
- Philips End-of-Life Disposal Information for UK only
- Waste Electrical and Electronic Equipment-WEEE
- China RoHS
- Troubleshooting Other Related Information

Regulatory Information

Model ID: 200BW8
Model No: HWS8200Q

CE Declaration of Conformity

Philips Consumer Electronics declare under our responsibility that the product is in conformity with the following standards

- EN60950-1:2001 (Safety requirement of Information Technology Equipment)
 - EN55022:1998 (Radio Disturbance requirement of Information Technology Equipment)
 - EN55024:1998 (Immunity requirement of Information Technology Equipment)
 - EN61000-3-2:2000 (Limits for Harmonic Current Emission)
 - EN61000-3-3:1995 (Limitation of Voltage Fluctuation and Flicker)
- following provisions of directives applicable
- 73/23/EEC (Low Voltage Directive)
 - 89/336/EEC (EMC Directive)
 - 93/68/EEC (Amendment of EMC and Low Voltage Directive)
- and is produced by a manufacturing organization on ISO9000 level.

The product also comply with the following standards

- ISO9241-3, ISO9241-7, ISO9241-8 (Ergonomic requirement for CRT Monitor)
- ISO13406-2 (Ergonomic requirement for Flat Panel Display)
- GS EK1-2000 (GS specification)
- prEN50279:1998 (Low Frequency Electric and Magnetic fields for Visual Display)
- MPR-II (MPR:1990:8/1990:10 Low Frequency Electric and Magnetic fields)
- TCO'99, TCO'03 (Requirement for Environment Labelling of Ergonomics, Energy, Ecology and Emission, TCO: Swedish Confederation of Professional Employees) for TCO versions

[RETURN TO TOP OF THE PAGE](#)

Energy Star Declaration

This monitor is equipped with a function for saving energy which supports the VESA Display Power Management Signaling (DPMS) standard. This means that the monitor must be connected to a computer which supports VESA DPMS. Time settings are adjusted from the system unit by software.

| NUTEK | VESA State | LED Indicator | Power Consumption |
|-------------------------------------|-------------|---------------|-------------------|
| Normal operation | ON (Active) | Green | < 47W (TYP) |
| Power Saving Alternative 2 One step | OFF (Sleep) | Amber | < 1 W |
| | Switch Off | OFF | < 1 W |



As an ENERGY STAR® Partner, PHILIPS has determined that this product meets the ENERGY STAR® guidelines for energy efficiency.



We recommend you switch off the monitor when it is not in use for a long time.

[RETURN TO TOP OF THE PAGE](#)

Federal Communications Commission (FCC) Notice (U.S. Only)



This equipment has been tested and found to comply with the limits for a Class B digital device, pursuant to Part 15 of the FCC Rules. These limits are designed to provide reasonable protection against harmful interference in a residential installation. This equipment generates, uses and can radiate radio frequency energy and, if not installed and used in accordance with the instructions, may cause harmful interference to radio communications. However, there is no guarantee that interference will not occur in a particular installation. If this equipment does cause harmful interference to radio or television reception, which can be determined by turning the equipment off and on, the user is encouraged to try to correct the interference by one or more of the following measures:

- Reorient or relocate the receiving antenna.
- Increase the separation between the equipment and receiver.
- Connect the equipment into an outlet on a circuit different from that to which the receiver is connected.
- Consult the dealer or an experienced radio/TV technician for help.



Changes or modifications not expressly approved by the party responsible for compliance could void the user's authority to operate the equipment.

Use only RF shielded cable that was supplied with the monitor when connecting this monitor to a computer device.

To prevent damage which may result in fire or shock hazard, do not expose this appliance to rain or excessive moisture.

THIS CLASS B DIGITAL APPARATUS MEETS ALL REQUIREMENTS OF THE CANADIAN INTERFERENCE-CAUSING EQUIPMENT REGULATIONS.

[RETURN TO TOP OF THE PAGE](#)

FCC Declaration of Conformity

Trade Name: Philips

Responsible Party: Philips Consumer Electronics North America
P.O. Box 671539
Marietta, GA 30006-0026
1-888-PHILIPS (744-5477)



This device complies with Part 15 of the FCC Rules. Operation is subject to the following two conditions: (1) this device may not cause harmful interference, and (2) this device must accept any interference received, including interference that may cause undesired operation.

[RETURN TO TOP OF THE PAGE](#)

Commission Federale de la Communication (FCC Declaration)



Cet équipement a été testé et déclaré conforme aux limites des appareils numériques de class B, aux termes de l'article 15 Des règles de la FCC. Ces limites sont conçues de façon à fournir une protection raisonnable contre les interférences nuisibles dans le cadre d'une installation résidentielle. CET appareil produit, utilise et peut émettre des hyperfréquences qui, si l'appareil n'est pas installé et utilisé selon les consignes données, peuvent causer des interférences nuisibles aux communications radio. Cependant, rien ne peut garantir l'absence d'interférences dans le cadre d'une installation particulière. Si cet appareil est la cause d'interférences nuisibles pour la réception des signaux de radio ou de télévision, ce qui peut être décelé en fermant l'équipement, puis en le remettant en fonction, l'utilisateur pourrait essayer de corriger la situation en prenant les mesures suivantes:

- Réorienter ou déplacer l'antenne de réception.
- Augmenter la distance entre l'équipement et le récepteur.
- Brancher l'équipement sur un autre circuit que celui utilisé par le récepteur.
- Demander l'aide du marchand ou d'un technicien chevronné en radio/télévision.



Toutes modifications n'ayant pas reçu l'approbation des services compétents en matière de conformité est susceptible d'interdire à l'utilisateur l'usage du présent équipement.

N'utiliser que des câbles RF armés pour les connections avec des ordinateurs ou périphériques.

CET APPAREIL NUMERIQUE DE LA CLASSE B RESPECTE TOUTES LES EXIGENCES DU REGLEMENT SUR LE MATERIEL BROUILLEUR DU CANADA.

[RETURN TO TOP OF THE PAGE](#)

EN 55022 Compliance (Czech Republic Only)

This device belongs to category B devices as described in EN 55022, unless it is specifically stated that it is a Class A device on the specification label. The following applies to devices in Class A of EN 55022 (radius of protection up to 30 meters). The user of the device is obliged to take all steps necessary to remove sources of interference to telecommunication or other devices.

Pokud není na typovém štítku počítače uvedeno, že spadá do do třídy A podle EN 55022, spadá automaticky do třídy B podle EN 55022. Pro zařízení zařazená do třídy A (chranné pásmo 30m) podle EN 55022 platí následující. Dojde-li k rušení telekomunikačních nebo jiných zařízení je uživatel povinen provést taková opatření, aby rušení odstranil.

VCCI Notice (Japan Only)

This is a Class B product based on the standard of the Voluntary Control Council for Interference (VCCI) for Information technology equipment. If this equipment is used near a radio or television receiver in a domestic environment, it may cause radio Interference. Install and use the equipment according to the instruction manual.

Class B ITE



この装置は、情報処理装置等電波障害自主規制協議会 (VCCI) の基準に基づくクラス B 情報技術装置です。この装置は家庭環境で使用することを目的としていますが、この装置がラジオやテレビジョン受信機に近接して使用されると、受信障害を引き起こすことがあります。取扱説明書に従って正しい取り扱いをして下さい。

MIC Notice (South Korea Only)

Class B Device

| 장치 종류 | 사용자 안내문 |
|-------|---|
| B급 기기 | 이 장치는 가정용으로 전자파 적합등록을 한 장치로서 주거지역에서는 물론 모든 지역에서 사용할 수 있습니다. |



Please note that this device has been approved for non-business purposes and may be used in any environment, including residential areas.

Polish Center for Testing and Certification Notice

The equipment should draw power from a socket with an attached protection circuit (a three-prong socket). All equipment that works together (computer, monitor, printer, and so on) should have the same power supply source.

The phasing conductor of the room's electrical installation should have a reserve short-circuit protection device in the form of a fuse with a nominal value no larger than 16 amperes (A).

To completely switch off the equipment, the power supply cable must be removed from the power supply socket, which should be located near the equipment and easily accessible.

A protection mark "B" confirms that the equipment is in compliance with the protection usage requirements of standards PN-93/T-42107 and PN-89/E-06251.

Wymagania Polskiego Centrum Badań i Certyfikacji

Urządzenie powinno być zasilane z gniazda z przyłączonym obwodem ochronnym (gniazdo z kołkiem). Współpracujące ze sobą urządzenia (komputer, monitor, drukarka) powinny być zasilane z tego samego źródła.

Instalacja elektryczna pomieszczenia powinna zawierać w przewodzie fazowym rezerwową ochronę przed zwarciami, w postaci bezpiecznika o wartości znamionowej nie większej niż 16A (amperów).

W celu całkowitego wyłączenia urządzenia z sieci zasilania, należy wyjąć wtyczkę kabla zasilającego z gniazdka, które powinno znajdować się w pobliżu urządzenia i być łatwo dostępne.

Znak bezpieczeństwa "B" potwierdza zgodność urządzenia z wymaganiami bezpieczeństwa użytkowania zawartymi w PN-93/T-42107 i PN-89/E-06251.

Pozostałe instrukcje bezpieczeństwa

- Nie należy używać wtyczek adapterowych lub usuwać kołka obwodu ochronnego z wtyczki. Jeżeli konieczne jest użycie przedłużacza to należy użyć przedłużacza 3-żyłowego z prawidłowo połączonym przewodem ochronnym.
- System komputerowy należy zabezpieczyć przed nagłymi, chwilowymi wzrostami lub spadkami napięcia, używając eliminatora przepięć, urządzenia dopasowującego lub bezzakłócenieniowego źródła zasilania.
- Należy upewnić się, aby nic nie leżało na kablach systemu komputerowego, oraz aby kable nie były umieszczone w miejscu, gdzie można byłoby na nie nadeptywać lub potykać się o nie.
- Nie należy rozlewać napojów ani innych płynów na system komputerowy.
- Nie należy wpychać żadnych przedmiotów do otworów systemu komputerowego, gdyż może to spowodować pożar lub porażenie prądem, poprzez zwarcie elementów wewnętrznych.
- System komputerowy powinien znajdować się z dala od grzejników i źródeł ciepła. Ponadto, nie należy blokować otworów wentylacyjnych. Należy unikać kładzenia luźnych papierów pod komputer oraz umieszczania komputera w ciasnym miejscu bez możliwości cyrkulacji powietrza wokół niego.

[RETURN TO TOP OF THE PAGE](#)

North Europe (Nordic Countries) Information

Placering/Ventilation

VARNING:

FÖRSÄKRA DIG OM ATT HUVUDBRYTARE OCH UTTAG ÄR LÄTÅTKOMLIGA, NÄR DU STÄLLER DIN UTRUSTNING PÅPLATS.

Placering/Ventilation

ADVARSEL:

SØRG VED PLACERINGS FOR, AT NETLEDNINGENS STIK OG STIKKONTAKT ER NEMT TILGÆNGELIGE.

Paikka/Ilmankierto

VAROITUS:

SIJOITA LAITE SITEN, ETTÄ VERKKOJOHTO VOIDAAN TARVITTAESSA HELPOSTI IRROTTAA PISTORASIASTA.

Plassering/Ventilasjon

ADVARSEL:

NÅR DETTE UTSTYRET PLOSSERES, MÅ DU PASSE PÅ AT KONTAKTENE FOR STØMTILFØRSEL ER LETTE Å NÅ.

[RETURN TO TOP OF THE PAGE](#)

BSMI Notice (Taiwan Only)

符合乙類資訊產品之標準

[RETURN TO TOP OF THE PAGE](#)

Ergonomie Hinweis (nur Deutschland)

Der von uns gelieferte Farbmonitor entspricht den in der "Verordnung über den Schutz vor Schäden durch Röntgenstrahlen" festgelegten Vorschriften.

Auf der Rückwand des Gerätes befindet sich ein Aufkleber, der auf die Unbedenklichkeit der Inbetriebnahme hinweist, da die Vorschriften über die Bauart von Störstrahlern nach Anlage III \times 5 Abs. 4 der Röntgenverordnung erfüllt sind.

Damit Ihr Monitor immer den in der Zulassung geforderten Werten entspricht, ist darauf zu achten, daß

1. Reparaturen nur durch Fachpersonal durchgeführt werden.
2. nur original-Ersatzteile verwendet werden.
3. bei Ersatz der Bildröhre nur eine bauartgleiche eingebaut wird.

Aus ergonomischen Gründen wird empfohlen, die Grundfarben Blau und Rot nicht auf dunklem Untergrund zu verwenden (schlechte Lesbarkeit und erhöhte Augenbelastung bei zu geringem Zeichenkontrast wären die Folge).

Der arbeitsplatzbezogene Schalldruckpegel nach DIN 45 635 beträgt 70dB (A) oder weniger.



ACHTUNG: BEIM AUFSTELLEN DIESES GERÄTES DARAUF ACHTEN, DAß NETZSTECKER UND NETZKABELANSCHLUß LEICHT ZUGÄNGLICH SIND.

End-of-Life Disposal

Your new monitor contains materials that can be recycled and reused. Specialized companies can recycle your product to increase the amount of reusable materials and to minimize the amount to be disposed of.

Please find out about the local regulations on how to dispose of your old monitor from your local Philips dealer.

(For customers in Canada and U.S.A.)

This product may contain lead and/or mercury. Dispose of in accordance to local-state and federal regulations.

For additional information on recycling contact www.eia.org (Consumer Education Initiative)

Information for UK only

WARNING - THIS APPLIANCE MUST BE EARTHED.

Important:

This apparatus is supplied with an approved moulded 13A plug. To change a fuse in this type of plug proceed as follows:

1. Remove fuse cover and fuse.
2. Fit new fuse which should be a BS 1362 5A, A.S.T.A. or BSI approved type.
3. Refit the fuse cover.

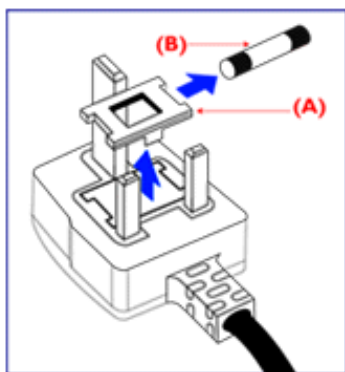

If the fitted plug is not suitable for your socket outlets, it should be cut off and an appropriate 3-pin plug fitted in its place.

If the mains plug contains a fuse, this should have a value of 5A. If a plug without a fuse is used, the fuse at the distribution board should not be greater than 5A.

Note: The severed plug must be destroyed to avoid a possible shock hazard should it be inserted into a 13A socket elsewhere.

How to connect a plug

The wires in the mains lead are coloured in accordance with the following code:

BLUE - "NEUTRAL" ("N")

BROWN - "LIVE" ("L")

GREEN & YELLOW - "EARTH" ("E")

1. The GREEN AND YELLOW wire must be connected to the terminal in the plug which is marked with the letter "E" or by the Earth symbol  or coloured GREEN or GREEN AND YELLOW.

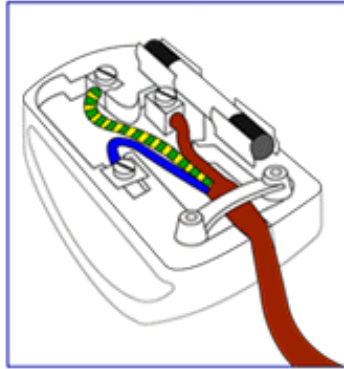

2. The BLUE wire must be connected to the terminal which is marked with the letter "N" or coloured BLACK.

3. The BROWN wire must be connected to the terminal which marked with the letter "L" or coloured RED.

Before replacing the plug cover, make certain that the cord grip is clamped over the sheath of the lead - not simply over the three wires.

RETURN TO TOP OF THE PAGE

Waste Electrical and Electronic Equipment-WEEE

Attention users in European Union private households



This marking on the product or on its packaging illustrates that, under European Directive 2002/96/EG governing used electrical and electronic appliances, this product may not be disposed of with normal household waste. You are responsible for disposal of this equipment through a designated waste electrical and electronic equipment collection. To determine the locations for dropping off such waste electrical and electronic, contact your local government office, the waste disposal organization that serves your household or the store at which you purchased the product.

China RoHS

China RoHS

The People's Republic of China released a regulation called "Management Methods for Controlling Pollution by Electronic Information Products" or commonly referred to as China RoHS. All products including CRT and LCD monitor which are produced and sold for China market have to meet China RoHS request.

中国大陆RoHS

根据中国大陆《电子信息产品污染控制管理办法》(也称为中国大陆RoHS),以下部分列出了本产品中可能包含的有毒有害物质或元素的名称和含量

本表示用之产品

显示器(液晶及CRT)

有毒有害物质或元素

| 部件名称 | 有毒有害物质或元素 | | | | | |
|----------|-----------|-----------|-----------|---------------|---------------|-----------------|
| | 铅 (Pb) | 汞 (Hg) | 镉 (Cd) | 六价镉 (Cr6+) | 多溴联苯 (PBB) | 多溴二苯醚 (PBDE) |
| 外壳 | ○ | ○ | ○ | ○ | ○ | ○ |
| CRT警示屏 | X | ○ | ○ | ○ | ○ | ○ |
| 液晶显示屏/灯管 | X | X | ○ | ○ | ○ | ○ |
| 电路板组件* | X | ○ | ○ | ○ | ○ | ○ |
| 电源适配器 | X | ○ | ○ | ○ | ○ | ○ |
| 电源线/连接线 | X | ○ | ○ | ○ | ○ | ○ |

*: 电路板组件包括印刷电路板及其构成的零部件,如电阻、电容、集成电路、连接器等
 ○: 表示该有毒有害物质在该部件所有均质材料中的含量均在《电子信息产品中有毒有害物质的限量要求标准》规定的限量要求以下
 X: 表示该有毒有害物质至少在该部件的某一均质材料中的含量超出《电子信息产品中有毒有害物质的限量要求标准》规定的限量要求;但是上表中打“X”的部件,符合欧盟RoHS法规要求(属于豁免的部份)

- Safety and Troubleshooting
- FAQs

Other Related Information

- Troubleshooting
- Regulatory Information
- Information for Users in the U.S
- Information for Users Outside the U.S

Information for Users in the U. S.

For units set at 115 V :

Use a UL Listed Cord Set consisting of a minimum 18 AWG, Type SVT or SJT three conductor cord a maximum of 15-feet long and a parallel blade, grounding type attachment plug rated 15 A, 125 V.

For units set at 230 V:

Use a UL Listed Cord Set consisting of a minimum 18 AWG, Type SVT or SJT three conductor cord a maximum of 15-feet long and a tandem blade, grounding type attachment plug rated 15 A, 250 V.

Information for Users outside the U.S.

For units set at 230 V:

Use a Cord Set consisting of a minimum 18 AWG cord and grounding type attachment plug rated 15 A, 250 V. The Cord Set should have the appropriate safety approvals for the country in which the equipment will be installed and / or be marked HAR.

[RETURN TO TOP OF THE PAGE](#)

About This Manual

About This Guide

This electronic user's guide is intended for anyone who uses the Philips LCD Monitor. It describes the LCD monitor's features, setup, operation and other important information. Its contents are identical to the information in our printed version.

It includes the following sections:

- **Safety and Troubleshooting Information** provides tips and solutions for common problems as well as other related information you may need.
- **About This Electronic User's Manual** gives an overview of information included, along with notation icon descriptions and other documentation for your reference.
- **Product Information** gives an overview of the monitor's features as well as the technical specifications for this monitor.
- **Installing Your Monitor** describes the initial setup process and gives an overview of how to use the monitor.
- **On-Screen Display** provides information on adjusting the settings on your monitor.
- **Customer Care and Warranty** contains a list of worldwide Philips Consumer Information Centers along with help desk phone numbers and information on the warranty applicable to your product.
- **Glossary** defines technical terms.
- **Download and Print Option** transfers this entire manual to your hard drive for easy reference.

[RETURN TO TOP OF THE PAGE](#)

Notational Descriptions

The following subsections describe notational conventions used in this document.

Notes, Cautions and Warnings

Throughout this guide, blocks of text may be accompanied by an icon and printed in bold or italic type. These blocks contain notes, cautions or warnings. They are used as follows:



NOTE: This icon indicates important information and tips that help you make better use of your computer system.



CAUTION: This icon indicates information that tells you how to avoid either potential damage to hardware or loss of data.



WARNING: This icon indicates the potential for bodily harm and tells you how to avoid the problem.

Some warnings may appear in alternate formats and may not be accompanied by an icon. In such cases, the specific presentation of the warning is mandated by the relevant regulatory authority.

[RETURN TO TOP OF THE PAGE](#)

©2007 Koninklijke Philips Electronics NV

All rights reserved. Reproduction, copying, use, modification, hiring, renting, public performance, transmission and/or broadcasting in whole or in part is prohibited without written consent of Philips Electronics NV

- [Product Features](#)
- [SmartImage Lite](#)
- [Smart Response](#)
- [Lead-free Product](#)
- [Technical Specifications](#)
- [Resolution & Preset Modes](#)
- [Philips Pixel Defect Policy](#)
- [Automatic Power Saving](#)
- [Physical Specification](#)
- [Pin Assignment](#)
- [Product Views](#)
- [Physical Function](#)
- [SmartManage](#)

Product Information

Product Features

200BW8

- **Designed for maximum productivity**
 - Tilt, swivel and height-adjust for an ideal viewing position
 - Big, widescreen ideal for viewing two A4 pages side-by-side
- **Best total cost of ownership solution**
 - Empowered for Windows Vista
 - Complies with RoHS standards to care for the environment
 - Power consumption below the industry average
- **Outstanding front of screen performance**
 - WSXGA, wide format 1680x1050 resolution for sharper display
 - 5ms fast response time
 - DVI-D input and HDCP support
- **Great convenience**
 - Dual input accepts both analog VGA and digital DVI signals
 - Built-in speakers for audio without desktop clutter
 - Adjust display settings with hot key or on-screen controls

[RETURN TO TOP OF THE PAGE](#)

SmartImage Lite (Selective Models)

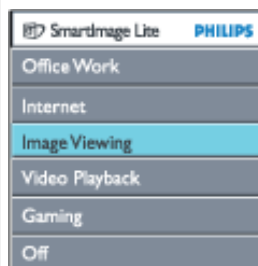

Introduction

Philips SmartImage Lite features with Philips LightFrame technology to enhance your front of screen performance depend by content type. It is changing brightness or contrast profiles to enrich color of image and sharpen text. No matter your application is on text processing or watching image or video, you can always get (Selective Models) best viewing experience from Philips SmartImage Lite.



How to enable SmartImage Lite



1. Press  to launch the SmartImage Lite on screen display;
2. Keep press  to toggle between Office Work, Internet, Image Viewing, Video Playback, Gaming, and Off;
3. The SmartImage Lite on screen display will remain on screen for 5 seconds or you can also press "OK" to make confirmation.
4. When smartImage Lite is enabled, the sRGB scheme is disabled automatically. To use sRGB you need to disable SmartImage Lite with the  button at the front bezel of your monitor

Except using  key to scroll down, you can also press   buttons to choose and press "ok" to confirm selection and close the SmartImage Lite OSD.

There are six modes to be selected:

1. **Office Work:** Select this mode for general office application, like word processing, spreadsheet, and email. The screen is dominated by text.
2. **Internet:** Select this mode for Internet application, especially web browsing. The screen is mixed by text and picture.
3. **Image Viewing:** Select this mode for image viewing application, especially in slid show. The screen is dominated by picture.
4. **Video Playback:** Select this mode for video application, like Microsoft Media Player or Real Player. The screen is dominated by video.
5. **Gaming:** Select this mode for PC game software. The screen is dominated by artificial animation with rich color.
6. **Off:** No optimization by SmartImage Lite.

SmartResponse (Selective Models) Product

What it is?

SmartResponse is exclusive Philips technology that adjusts response time to application requirements, delivering faster response times for gaming and videos or better color saturation for viewing photos and static images.

Why Need it?

You want optimal display for every type of application: Static or steady image display without 'noise' or color shifting as well as blurring and ghosting-free performance when viewing action movies or videos.

How to use it?

Select the video and gaming playback profile to ramp up response time for blur and ghosting-free display of fast-moving images in action movies or videos; choose the image viewing profile for optimal display of steady or static images without "noise" or color shifting when working with image viewing or other multipurpose applications.

Where will it be effective?

1. When you select SmartImage Lite profiles from SmartImage button, certain preset profiles

had configured proper SmartResponse setting.

- a. Internet - SmartResponse will turn on with low level enhancement to reduce motion blur when scrolling web page.
 - b. Video Playback - SmartResponse will turn on with medium level enhancement to reduce motion blur.
 - c. Gaming - SmartResponse will turn on with high level enhancement to give gamer fastest LCD display response.
 - d. Other profiles settings like, "Office Work", "Image Viewing" and "Off", turn off "SmartResponse " to offer optimal color performance.
2. You can also turn it "on" or "off" manually via OSD/More Settings/SmartResponse. The default setting is "off".

[RETURN TO TOP OF THE PAGE](#)

Lead-free Product



Philips eliminated toxic substances like lead from its displays. Lead-free display helps protect your health and promotes environmentally sound recovery and disposal of waste from electrical and electronic equipment. Philips complies with the European Community stringent RoHS Directive mandating restrictions on hazardous substances in electrical and electronic equipment. With Philips, you can be confident that your display device does not harm the environment.

Technical Specifications*

| LCD PANEL | |
|--------------------------|---|
| • Type | TFT LCD |
| • Screen size | 20" / 51 cm diagonal |
| • Pixel Pitch | 0.258 x 0.258 mm |
| • LCD Panel type | 1680 x 1050 pixels R.G.B. vertical stripe Anti-glare polarizer, hard coated |
| • Effective viewing area | 433.44 x 270.90 mm |
| SCANNING | |
| Vertical refresh rate | 56 Hz-76 Hz |
| Horizontal Frequency | 30 kHz-83 kHz |
| VIDEO | |
| • Video dot rate | 165 MHz |
| • Input impedance | |
| - Video | 75 ohm |
| - Sync | 2.2K ohm |

| | |
|--------------------------------------|--|
| • Input signal levels | 0.7 Vpp |
| • Sync input signal | Separate sync Composite sync Sync on green |
| • Sync polarities | Positive and negative |
| • Video interface | Dual input: D-Sub (analog) and DVI-D (digital) are available and user selectable |
| • SmartImage Lite (Selective Models) | Brightness, contrast, color, and sharpness enhancement |
| Audio (Selective Models) | |
| • Loudspeaker | 1W+1W Stereo Audio (1W/channel RMSx2, 20 Hz-20 kHz, 8 ohm) |
| • Stand-alone audio output | Whether there is a video display or not as long as there is an audio input, the audio output is always functional. |
| Optical characteristics | |
| • Peak contrast angle | 6 o'clock |
| • White Chromaticity | x: 0.283 y: 0.297 (at 9300°K) x: 0.313 y: 0.329 (at 6500°K) x: 0.313 y: 0.329 (at sRGB) |

* This data is subject to change without notice.

[RETURN TO TOP OF THE PAGE](#)

Resolution & Preset Modes

- Maximum 1680 x 1050 at 60 Hz (analog input)
1680 x 1050 at 60 Hz (digital input)
- Recommended 1680 x 1050 at 60 Hz (digital input)

24 user definable modes

18 factory preset modes:

| H.freq (kHz) | Resolution | V. freq (Hz) |
|--------------|------------|----------------|
| 31.47 | 640*350 | 70 |
| 31.47 | 640*480 | 60 |
| 35 | 640*480 | 67 |
| 37.5 | 640*480 | 75 |
| 31.47 | 720*400 | 70 |
| 35.16 | 800*600 | 56 |
| 37.88 | 800*600 | 60 |
| 46.88 | 800*600 | 75 |
| 48.36 | 1024*768 | 60 |
| 60.02 | 1024*768 | 75 |
| 63.98 | 1280*1024 | 60 |
| 79.98 | 1280*1024 | 75 |
| 55.47 | 1440*900 | 60 |
| 55.94 | 1440*900 | 60 |
| 70.64 | 1440*900 | 75 |
| 65.29 | 1680*1050 | 60 |
| 64.67 | 1680*1050 | 60 |
| 66.59 | 1920*1080 | 60 (for DVI-D) |

[RETURN TO TOP OF THE PAGE](#)

Automatic Power Saving

If you have VESA DPMS compliance display card or software installed in your PC, the monitor can automatically reduce its power consumption when not in use. If an input from a keyboard, mouse or other input device is detected, the monitor will 'wake up' automatically. The following table shows the power consumption and signaling of this automatic power saving feature:

| Power Management Definition | | | | | |
|-----------------------------|-------|--------|--------|--------------|-----------|
| VESA Mode | Video | H-sync | V-sync | Power Used | LED color |
| Active | ON | Yes | Yes | < 47 W (TYP) | Green |
| Sleep | OFF | No | No | < 1 W | Amber |
| Switch Off | OFF | - | - | < 1W | Off |

This monitor is ENERGY STAR® compliant. As an ENERGY STAR® Partner, PHILIPS has determined that this product meets the ENERGY STAR® guidelines for energy efficiency.

[RETURN TO TOP OF THE PAGE](#)

Physical Specifications

| | |
|---------------------------------|--|
| • Dimension with Stand (WxHxD) | 473 x 343 x 213 mm |
| • Weight | 6.7 kg |
| • Tilt / swivel | -5° ~+20°/ -45°~+45° |
| • Height adjustment range | 130 mm |
| • Power supply | 100 — 240 VAC, 60 — 50 Hz |
| • Power consumption | 47 W* (TYP) |
| • Temperature | 5° C to 35° C (operating) -20° C to 60° C (storage) |
| • Relative humidity | 10% to 85% |
| • System MTBF | 50K hours (including CCFL 40K hours) |
| • Cabinet color | 200BW8: Black/Silver |

* This data is subject to change without notice.

* Resolution 1680X1050, standard size, brightness max., contrast 50%, 6500° K, full white pattern, without audio/USB.

[RETURN TO TOP OF THE PAGE](#)

Pin Assignment

1. The digital only connector contains 24 signal contacts organized in three rows of eight contacts. Signal pin assignments are listed in the following table:

| Pin No. | Signal Assignment | Pin No. | Signal Assignment | Pin No. | Signal Assignment |
|---------|-------------------------|---------|-------------------------|---------|-------------------------|
| 1 | T.M.D.S. Data2- | 9 | T.M.D.S. Data1- | 17 | T.M.D.S. Data0- |
| 2 | T.M.D.S. Data2+ | 10 | T.M.D.S. Data1+ | 18 | T.M.D.S. Data0+ |
| 3 | T.M.D.S. Data2/4 Shield | 11 | T.M.D.S. Data1/3 Shield | 19 | T.M.D.S. Data0/5 Shield |
| 4 | No connect | 12 | No connect | 20 | No connect |
| 5 | No connect | 13 | No connect | 21 | No connect |
| 6 | DDC Clock | 14 | +5V Power | 22 | T.M.D.S. Clock Shield |
| 7 | DDC Data | 15 | Ground (for +5V) | 23 | T.M.D.S. Clock+ |
| 8 | No connect | 16 | Hot Plug Detect | 24 | T.M.D.S. Clock- |



2. The 15-pin D-sub connector (male) of the signal cable:

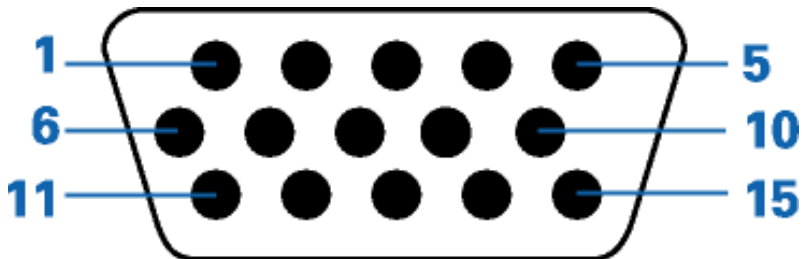

| Pin No. | Assignment | Pin No. | Assignment |
|---------|-----------------------|---------|------------------------|
| 1 | Red video input | 9 | +5V |
| 2 | Green video input/SOG | 10 | Logic ground |
| 3 | Blue video input | 11 | Ground |
| 4 | Sense (GND) | 12 | Serial data line (SDA) |
| 5 | Hot Plug Detect | 13 | H. Sync / H+V |
| 6 | Red video ground | 14 | V. Sync (VCLK for DDC) |
| 7 | Green video ground | 15 | Data clock line (SCL) |
| 8 | Blue video ground | | |

[RETURN TO TOP OF THE PAGE](#)

Product Views

Follow the links to see various views of the monitor and its components.

Front View Product Description

[RETURN TO TOP OF THE PAGE](#)

Physical Function

1) Tilt

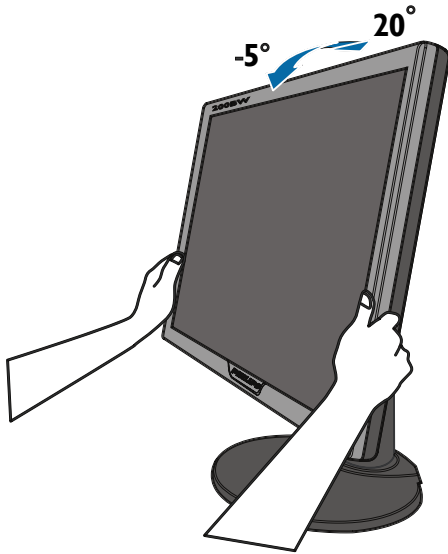

2) Swivel

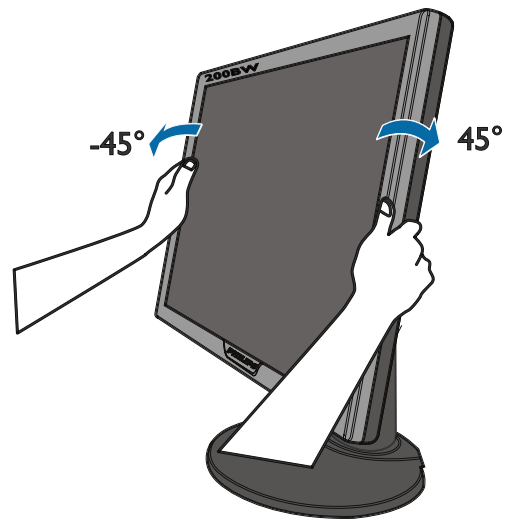

3) Height adjustment

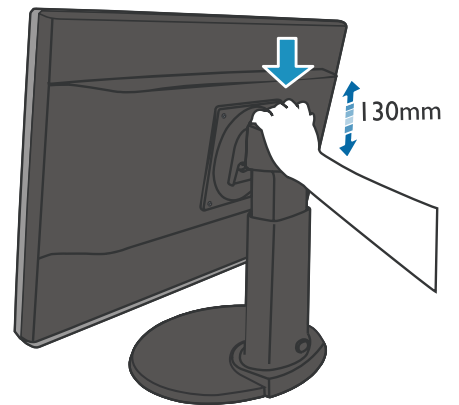
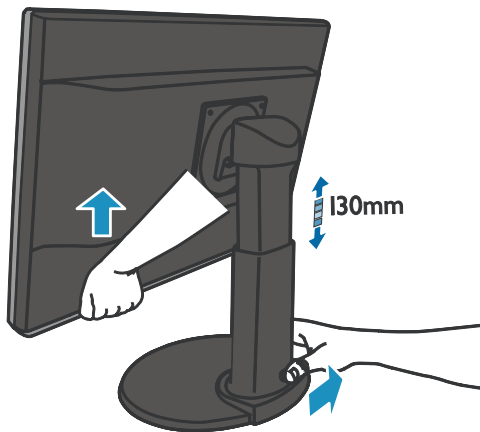

[RETURN TO TOP OF THE PAGE](#)

- Product Features
- Technical Specifications
- Resolution & Preset Modes
- Automatic Power Saving
- Physical Specification
- Pin Assignment
- Product Views

Philips Pixel Defect Policy

Philips' Flat Panel Monitors Pixel Defect Policy

Philips strives to deliver the highest quality products. We use some of the industry's most advanced manufacturing processes and practice stringent quality control. However, pixel or sub pixel defects on the TFT LCD panels used in flat panel monitors are sometimes unavoidable. No manufacturer can guarantee that all panels will be free from pixel defects, but Philips guarantees that any monitor with an unacceptable number of defects will be repaired or replaced under warranty. This notice explains the different types of pixel defects and defines acceptable defect levels for each type. In order to qualify for repair or replacement under warranty, the number of pixel defects on a TFT LCD panel must exceed these acceptable levels. For example, no more than 0.0004% of the sub pixels on a 15" XGA monitor may be defective. Furthermore, Philips sets even higher quality standards for certain types or combinations of pixel defects that are more noticeable than others. This policy is valid worldwide.

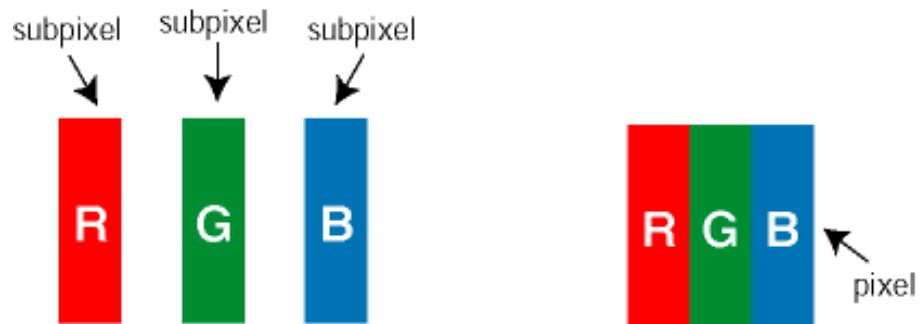

Pixels and Sub pixels

A pixel, or picture element, is composed of three sub pixels in the primary colors of red, green and blue. Many pixels together form an image. When all sub pixels of a pixel are lit, the three colored sub pixels together appear as a single white pixel. When all are dark, the three colored sub pixels together appear as a single black pixel. Other combinations of lit and dark sub pixels appear as single pixels of other colors.

Types of Pixel Defects

Pixel and sub pixel defects appear on the screen in different ways. There are two categories of pixel defects and several types of sub pixel defects within each category.

Bright Dot Defects Bright dot defects appear as pixels or sub pixels that are always lit or 'on'. That is, a *bright dot* is a sub-pixel that stands out on the screen when the monitor displays a dark pattern. There are the types of bright dot defects:

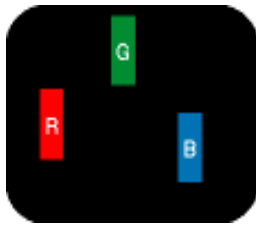

One lit red, green or blue sub pixel

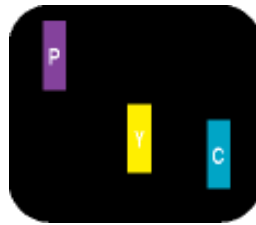

Two adjacent lit sub pixels:

- Red + Blue = Purple
- Red + Green = Yellow
- Green + Blue = Cyan (Light Blue)



Three adjacent lit sub pixels (one white pixel)



A red or blue *bright dot* must be more than 50 percent brighter than neighboring dots while a green bright dot is 30 percent brighter than neighboring dots.

Black Dot Defects Black dot defects appear as pixels or sub pixels that are always dark or 'off'. That is, a *dark dot* is a sub-pixel that stands out on the screen when the monitor displays a light pattern. These are the types of black dot defects:

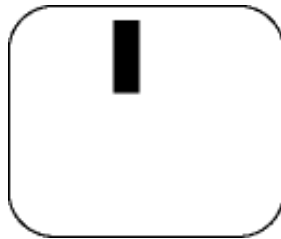

One dark sub pixel

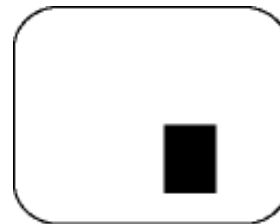

Two or three adjacent dark sub pixels

Proximity of Pixel Defects

Because pixel and sub pixels defects of the same type that are near to one another may be more noticeable, Philips also specifies tolerances for the proximity of pixel defects.

| BRIGHT DOT DEFECTS | ACCEPTABLE LEVEL |
|--|------------------|
| MODEL | 200BW8 |
| 1 lit subpixel | 3 |
| 2 adjacent lit subpixels | 1 |
| 3 adjacent lit subpixels (one white pixel) | 0 |
| Distance between two bright dot defects* | 15mm |
| Total bright dot defects of all types | 3 |

| BLACK DOT DEFECTS | ACCEPTABLE LEVEL |
|---|------------------|
| MODEL | 200BW8 |
| 1 dark subpixel | 5 |
| 2 adjacent dark subpixels | 2 |
| 3 adjacent dark subpixels | 0 |
| Distance between two black dot defects* | 15mm |
| Total black dot defects of all types | 5 |

| TOTAL DOT DEFECTS | ACCEPTABLE LEVEL |
|--|------------------|
| MODEL | 200BW8 |
| Total bright or black dot defects of all types | 5 |

Note:

* 1 or 2 adjacent sub pixel defects = 1 dot defect

Your Philips monitor is ISO13406-2 Compliant

[RETURN TO TOP OF THE PAGE](#)

- Product Information
- Philips Pixel Defect Policy
- SmartManage Introduction
- SmartManage Features and Benefits
- Philips SmartControl
- Q&A

SmartManage & SmartControl (Selective Models)



Introduction

Philips SmartManage is an advanced solution for users, corporate/institution IT administrator in particular, to manage their Philips monitors as part of the asset management environment. The solution includes three essential components, Philips SmartManage Administrator, and Philips SmartControl and Agent.

Philips SmartManage is a solution joint developed by Philips and Altiris Inc.

SmartManage Features and Benefits

The Philips SmartManage is a working console for IT management to gather monitors assets information, run asset report, control assets security, monitor assets security, and issue instant messages to monitor users.

Philips SmartManage includes the following major features:

1. Provides an additional security measure that helps corporate users safeguard their investment.
2. Power saving feature that reduces utility costs and manpower required to turn monitors on or off.
3. Provides an efficient means for adjusting monitor performance and settings.
4. Built-in asset reports reduce audit/maintenance manpower, cycle time and costs.

A trial version of SmartManage can be downloaded from <http://www.altiris.com/philips>

For more information of Philips SmartManage, please contact with Philips sales representatives in your country.



SmartManage is a software dedicated to business environments. Personal users normally do not need to use SmartManage.

Philips SmartControl

The SmartControl and SmartManage Agent are deployed and installed in computers using Philips monitors. With SmartControl and SmartManage Agent, monitors and PCs can interact with the administrator's inquiries. Because SmartControl operates on individual PC, end users can also use SmartControl to adjust monitor's performance settings.

1. Requirement

- Graphic cards with nVIDIA (TNT2, GeForce, Quadro, or newer) and ATI (Radeon or newer) graphic chipsets that support the DDC/CI interface
- Microsoft Windows 2000 and XP operation systems.
- Philips monitors supporting DDC/CI interface

2. Installation

How to download "SmartControl Installation " file:

1. Visit [http:// www.philips.com](http://www.philips.com)
2. Select "Your Country"
3. Click on "Contact & Support"
4. Enter your model number
5. Enter "Software & Driver" page
6. Select "SmartControl Software", and you can download SmartControl and its driver for installation.

3. Accessing SmartControl

- Right click on the desktop of your PC, and select Properties from the shortcut menu pops up.
- Click on Settings tab, and click on Advanced button.
- Click Philips SmartControl tab.

4. SmartControl Options

- **Display and Sound**
By moving the sliding bar toward left or right, users will be able to adjust brightness, contrast, audio volume (if applicable), video noise (not applicable when using DVI-D input), and color temperatures.

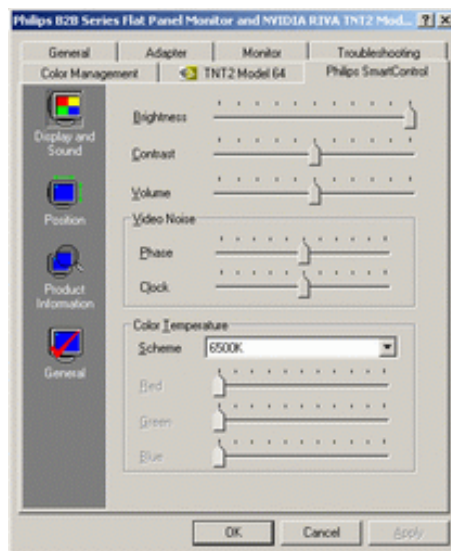

- **Position**
Users can adjust the horizontal and vertical position of the screen by moving the sliding bar left and right. This function is disabled when using DVI-D (digit) input.

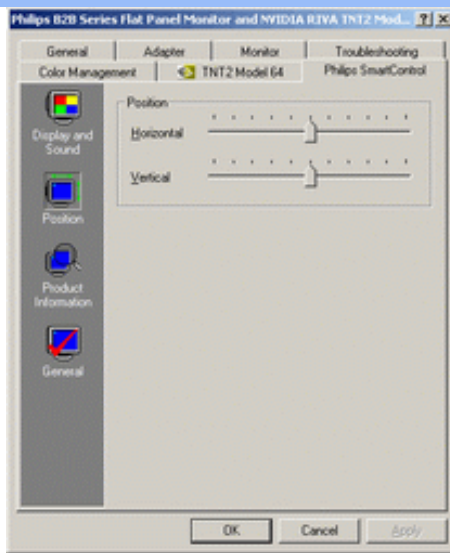

- **Product Information**

Click **Product Information** in the left pane to view the product information stored in the monitor's memory.

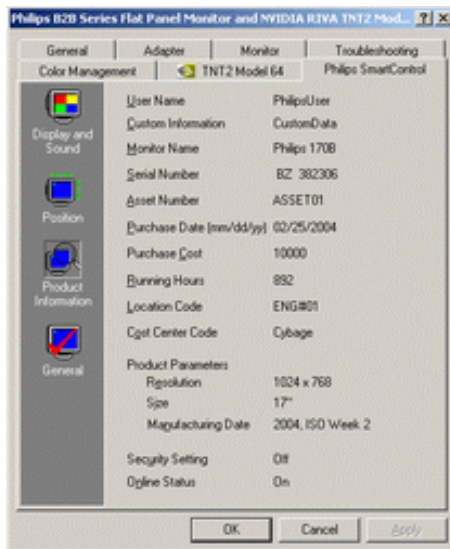

- **General**

Click on **General** for general information including driver information, device information, and monitor control.

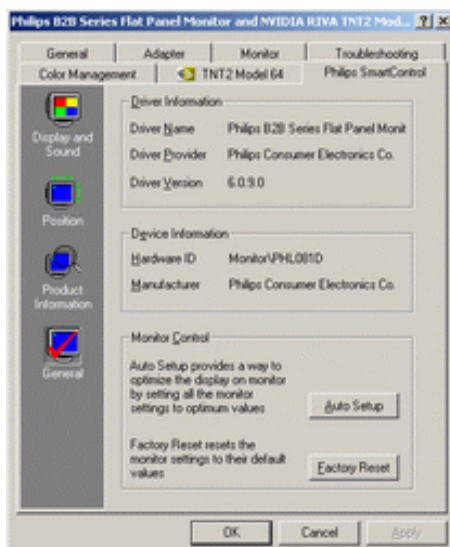

Within monitor control, users can click on **Auto Setup** to achieve optimum performance or

click on factory reset to reset the parameters of the monitor. Such choices are disabled when using DVI-D (digit) input.

Q&A

Q1. What is the difference between SmartManage, SmartControl?

A. SmartManage is a remote management/control software for IT managers to manage monitors across the network

SmartControl is a control panel extension, which helps users to adjust monitor performances and settings by a software interface, instead of the hardware buttons at the front bezel of the monitors.

Q2. I change the monitor on a PC to a different one and the SmartControl becomes unusable, what do I do?

A. Restart your PC and see if SmartControl can work. Otherwise, you will need to remove and re-install SmartControl to ensure proper driver is installed.

Q3. The SmartControl functions well at the beginning, but it is not workable, what can I do?

A. If the following actions were executed, the monitor driver may need to be re-installed.

- Change video graphic adapter to another one
- Update video driver
- Activities on OS, such as service pack or patch
- Run Windows Update and updated monitor and/or video driver
- Windows was booted with the monitor power off or disconnected.

To find out, please right click My Computer and click on Properties->Hardware-> Device Manager.

If you see "Plug and Play Monitor" shows under Monitor, then you need to re-install. Simply remove SmartControl and re-install it.

Q4. After installing SmartControl, when clicking on SmartControl tab, nothing shows up after a while or a failure message shows, what happened?

A. It might be your graphic adaptor is not compatible with the SmartControl. If your graphic adaptor is one of the above mentioned brands, try to download the most updated graphic adaptor driver from corresponding companies' web site. Install the driver. Remove SmartControl, and re-install it once more.

If it is still not working, we are sorry that the graphic adaptor is not supported. Please pay attention to Philips' web site for any updated SmartControl driver available.

Q5. When I click on Product Information, only partial information is shown, what happened?

A. It might be your graphic card adaptor driver is not the most updated version which fully supporting DDC/CI interface. Please try to download the most updated graphic adaptor driver from corresponding companies' web site. Install the driver. Remove SmartControl, and re-install it once more.

[RETURN TO TOP OF THE PAGE](#)

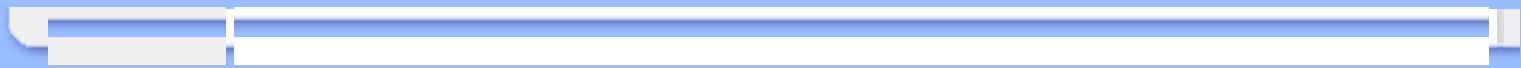



Installing Your LCD Monitor

- Front View
- Product Description
- Connecting to Your PC
- Getting Started
- Optimizing Performance

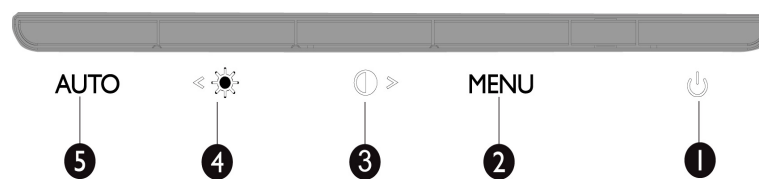
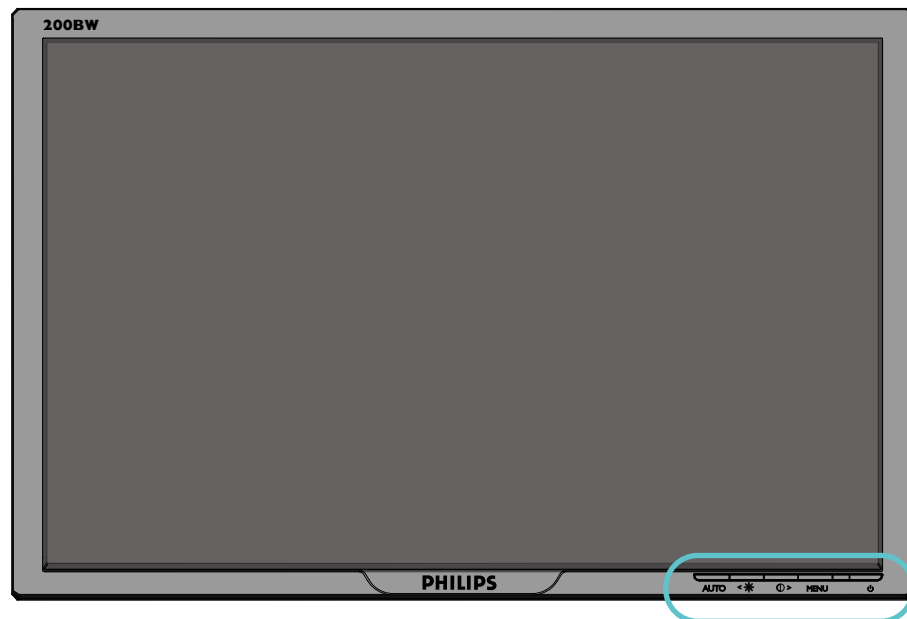
Front View Product Description



-  To switch monitor's power on and off
- MENU** To access OSD menu
-  Hot key of Contrast adjustment and To adjust OSD value up when OSD menu is active
-  Hot key of Brightness adjustment and To adjust OSD value down when OSD menu is active
- AUTO** Automatically adjust the horizontal position, vertical position, phase and clock settings

[RETURN TO TOP OF THE PAGE](#)

Rear View

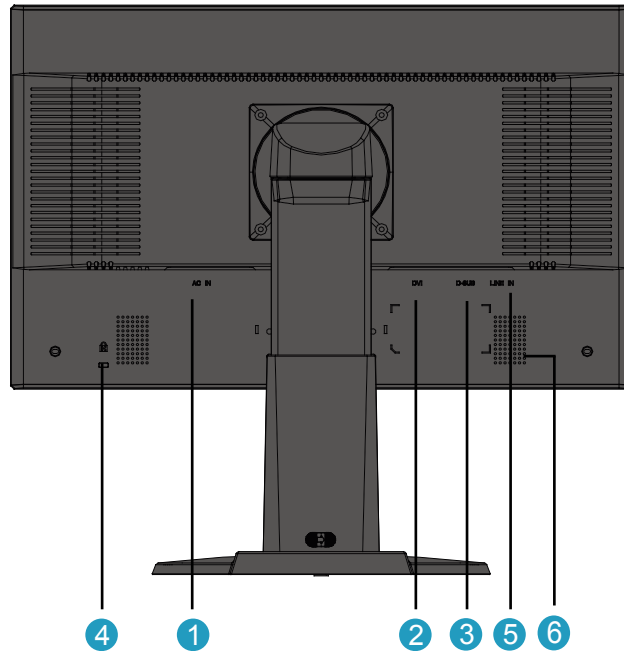

- 1 AC power input
- 2 DVI-D input
- 3 VGA input
- 4 Kensington anti-theft lock
- 5 PC Audio input
- 6 Speaker

[RETURN TO TOP OF THE PAGE](#)

Optimizing Performance

For best performance, ensure that your display settings are set at 1680x1050, 60Hz.



Note: To check the current display resolution, press the 'OK' button once. The current display mode is shown on the OSD. If the display setting is not optimized, a warning string "USE 1680x1050 FOR BEST RESULT" appears in the OSD menu.

You can also install the [Flat Panel Adjust \(FP Adjustment\) program](#), a program for getting the best performance out of your monitor. This is included on this CD. Step-by-step instructions are provided to guide you through the installation process. Click on the link to know more about this program.

More about  [FP_setup4.3.exe](#)

[RETURN TO TOP OF THE PAGE](#)

Connecting to Your PC

- Front View
- Product Description
- Accessory Pack
- Connecting to Your PC
- Getting Started
- Optimizing Performance

Accessory Pack

Unpack all the parts.



Power cord



VGA cable



EDFU CD



DVI cable (Optional)

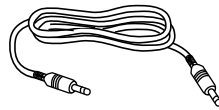

Audio cable

[RETURN TO TOP OF THE PAGE](#)

Connecting to Your PC

1)



2)

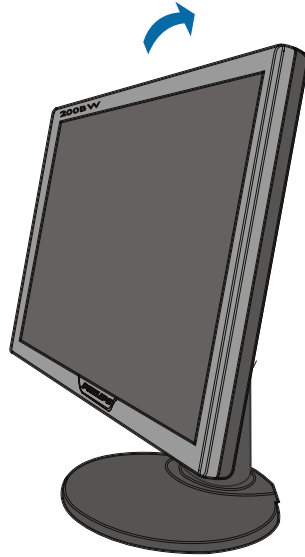

3) Cable management

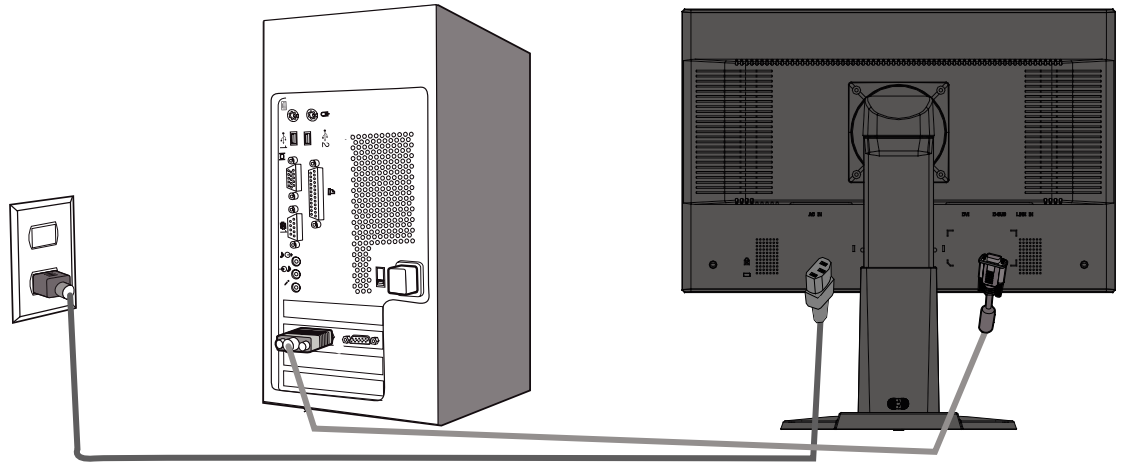

4) Connect to PC

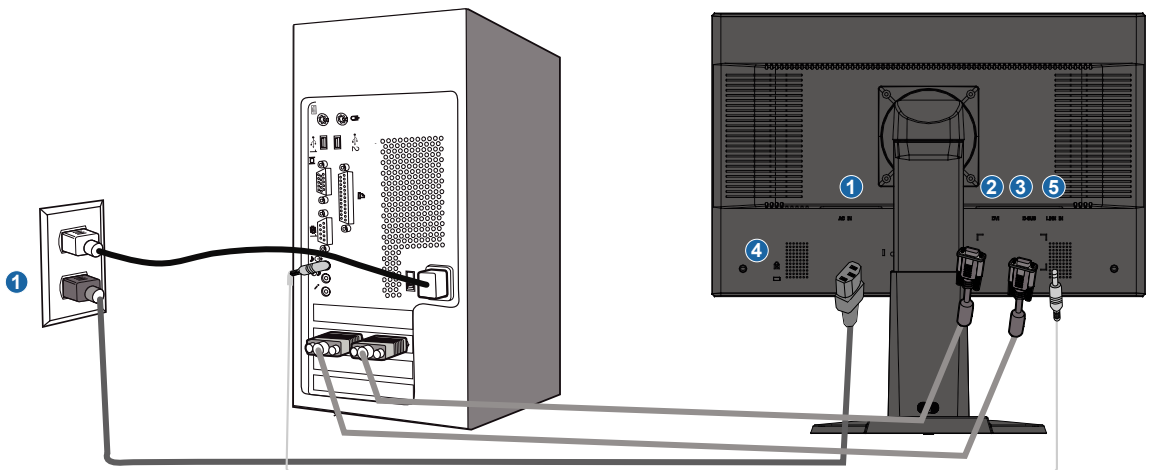

- (1) AC power input**
- (2) DVI-D input**
- (3) VGA input**
- (4) Kensington anti-thief lock**
- (5) PC Audio input**
- (6) Set your Monitor at 1680x1050@60Hz for best performance. It is also strongly recommended to use DVI input (may require the optional DVI cable) for the true digital enjoyment.**

[RETURN TO TOP OF THE PAGE](#)

Your LCD Monitor :

- Front View Product Description
- Setting Up and Connecting Your Monitor
- Getting Started
- Optimizing Performance

Getting Started

Getting Started

Use the information file (.inf) for Windows® 95/98/2000/Me/XP/Vista or later

The built-in VESA DDC2B feature in Philips Monitors supports Plug & Play requirements for Windows® 95/98/2000/Me/XP/Vista. This information file (.inf) should be installed in order that your Philips monitor can be enabled from the 'Monitor' dialog box in Windows® 95/98/2000/Me/XP/Vista and the Plug & Play application can be activated. The installation procedure based on Windows® '95 OEM Release 2 , 98 , 2000,Me, XP and Vista is specified as follows.

For Windows® 95

1. Start Windows® '95
2. Click on the 'Start' button, point to 'Settings', and then click on 'Control Panel'.
3. Double click on the 'Display' Icon.
4. Select the 'Settings' tab then click on 'Advanced...'
5. Select the 'Monitor' button, point to 'Change...' then click on 'Have Disk...'
6. Click on the 'Browse...' button, select the appropriate drive F: (CD-ROM Drive) then click on the 'OK' button.
7. Click on the 'OK' button then select your monitor model and click on 'OK'.
8. Click on the 'Close' button.

For Windows® 98

1. Start Windows® 98
2. Click on the 'Start' button, point to 'Settings', and then click on 'Control Panel'.
3. Double click on the 'Display' Icon.
4. Select the 'Settings' tab then click on 'Advanced...'
5. Select the 'Monitor' button, point to 'Change...' then click on 'Next'
6. Select 'Display a list of all the drivers in a specific location, so you can choose the driver you want.' then click on 'Next' and then click on 'Have Disk...'
7. Click on the 'Browse...' button, select the appropriate drive F: (CD-ROM Drive) then click on the 'OK' button.
8. Click on the 'OK' button then select your monitor model and click on the 'Next' button.
9. Click on the 'Finish' button then the 'Close' button.

For Windows® 2000

1. Start Windows® 2000
2. Click on the 'Start' button, point to 'Settings', and then click on 'Control Panel'.
3. Double click on the 'Display' Icon.
4. Select the 'Settings' tab then click on 'Advanced...'
5. Select 'Monitor'
 - If the 'Properties' button is inactive, it means your monitor is properly configured. Please stop installation.
 - If the 'Properties' button is active. Click on 'Properties' button. Please follow the steps given below.
6. Click on 'Driver' and then click on 'Update Driver...' then click on the 'Next' button.

7. Select 'Display a list of the known drivers for this device so that I can choose a specific driver', then click on 'Next' and then click on 'Have disk...'.
8. Click on the 'Browse...' button then select the appropriate drive F: (CD-ROM Drive).
9. Click on the 'Open' button, then click on the 'OK' button.
10. Select your monitor model and click on the 'Next' button.
11. Click on the 'Finish' button then the 'Close' button.
If you can see the 'Digital Signature Not Found' window, click on the 'Yes' button.

For Windows® Me

1. Start Windows® Me
2. Click on the 'Start' button, point to 'Settings', and then click on 'Control Panel'.
3. Double click on the 'Display' icon.
4. Select the 'Settings' tab then click on 'Advanced...'.
5. Select the 'Monitor' button, then click on 'Change...' button.
6. Select 'Specify the location of the driver(Advanced)' and click on the 'Next' button.
7. Select 'Display a list of all the drivers in a specific location, so you can choose the driver you want', then click on 'Next' and then click on 'Have Disk...'.
8. Click on the 'Browse...' button, select the appropriate drive F: (CD-ROM Drive) then click on the 'OK' button.
9. Click on the 'OK' button, select your monitor model and click on the 'Next' button.
10. Click on 'Finish' button then the 'Close' button.

For Windows® XP

1. Start Windows® XP
2. Click on the 'Start' button and then click on 'Control Panel'.
3. Select and click on the category 'Printers and Other Hardware'
4. Click on the 'Display' item.
5. Select the 'Settings' tab then click on the 'Advanced' button.
6. Select 'Monitor' tab
 - If the 'Properties' button is inactive, it means your monitor is properly configured. Please stop installation.
 - If the 'Properties' button is active, click on 'Properties' button. Please follow the steps below.
7. Click on the 'Driver' tab and then click on 'Update Driver...' button.
8. Select the 'Install from a list or specific location [advanced]' radio button and then click on the 'Next' button.
9. Select the 'Don't Search. I will choose the driver to install' radio button. Then click on the 'Next' button.
10. Click on the 'Have disk...' button, then click on the 'Browse...' button and then select the appropriate drive F: (CD-ROM Drive).
11. Click on the 'Open' button, then click the 'OK' button.
12. Select your monitor model and click on the 'Next' button.
 - If you can see the 'has not passed Windows® Logo testing to verify its compatibility with Windows® XP' message, please click on the 'Continue Anyway' button.
13. Click on the 'Finish' button then the 'Close' button.
14. Click on the 'OK' button and then the 'OK' button again to close the Display_Properties dialog box.

For Windows® Vista

1. Start Windows® Vista
2. Click the Start button; select and click on 'Control Panel'.
3. Select and click on 'Hardware and Sound'
4. Choose 'Device Manager' and Click on 'Update device drivers'.
5. Select 'Monitor' and then right click on 'Generic PnP Monitor'.
6. Click on 'Update Driver Software'.
7. Select 'Browse my computer for driver software'.
8. Click the 'Browse' button and choose the drive in which you've placed the disk.
Example: (CD-ROM Drive:\\Lcd\\PC\\drivers\\).
9. Click the 'Next' button.
10. Wait few minutes for installing the driver, and then click 'Close' button.

If your Windows® 95/98/2000/Me/XP/Vista version is different or you need more detailed installation information, please refer to your Windows® 95/98/2000/Me/XP/Vista user's manual.

[RETURN TO TOP OF THE PAGE](#)

On-Screen Display

- Description of the On-Screen Display
- The OSD Tree

Description of the On Screen Display

What is the On-Screen Display?

On-Screen Display (OSD) is a feature in all Philips LCD monitors. It allows an end user to adjust screen performance or select functions of the monitors directly through an on-screen instruction window. A user friendly on screen display interface is shown as below :

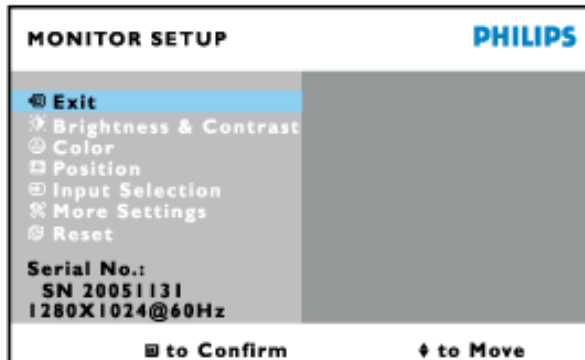

Basic and simple instruction on the control keys.

In the OSD shown above users can press ▲▼ buttons on the right side of the monitor to move the cursor,  to confirm the choice or change, and ◀▶ to adjust/select the change.

[RETURN TO TOP OF THE PAGE](#)

The OSD Tree

Below is an overall view of the structure of the On-Screen Display. You can use this as a reference when you want to work your way around the different adjustments later on.

only available for Europe Model

Main Menu

Sub Menu

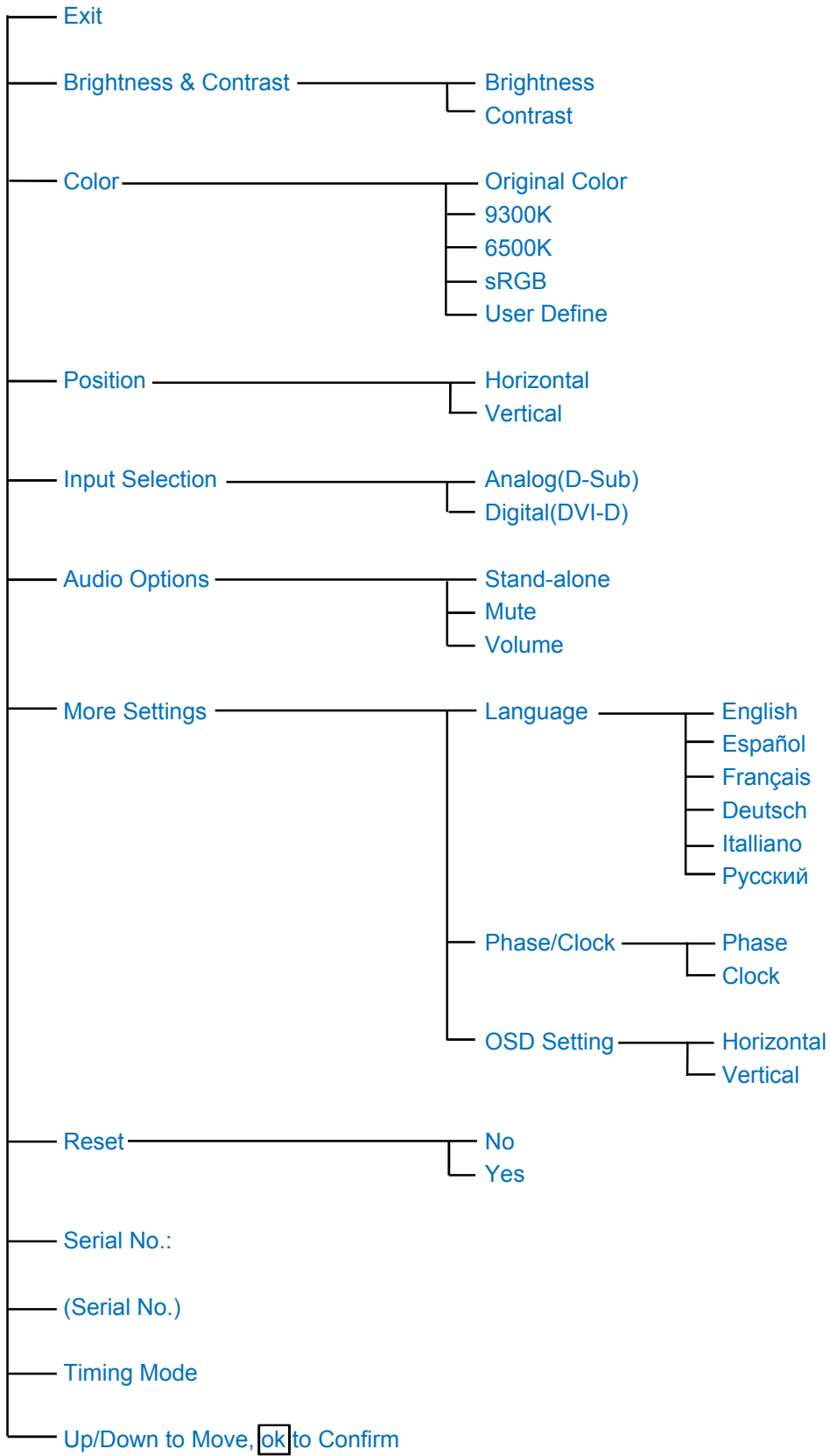

only available for Nafta Model

Main Menu

Sub Menu

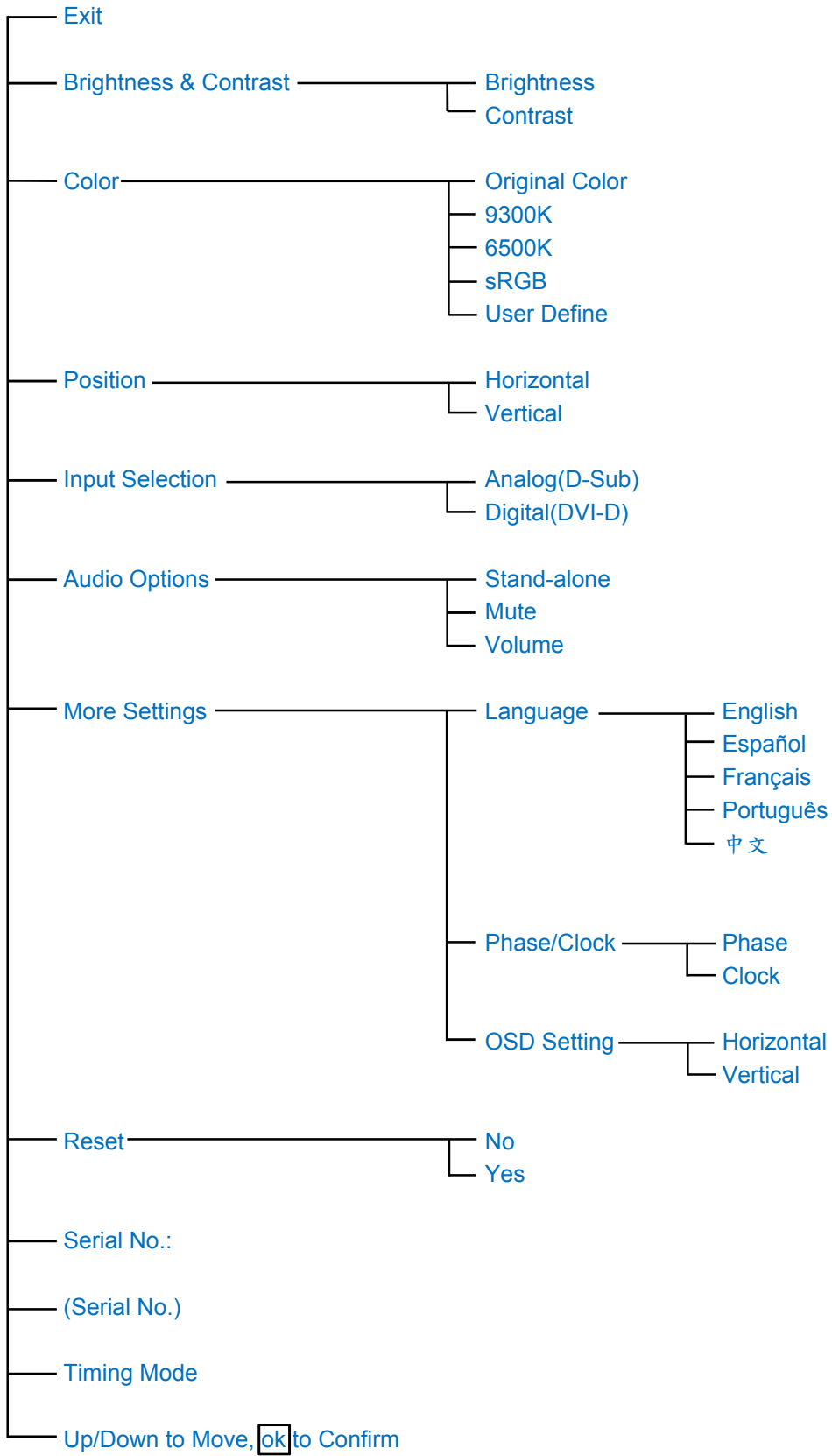

only available for Asia Pacific Model

Main Menu

Sub Menu

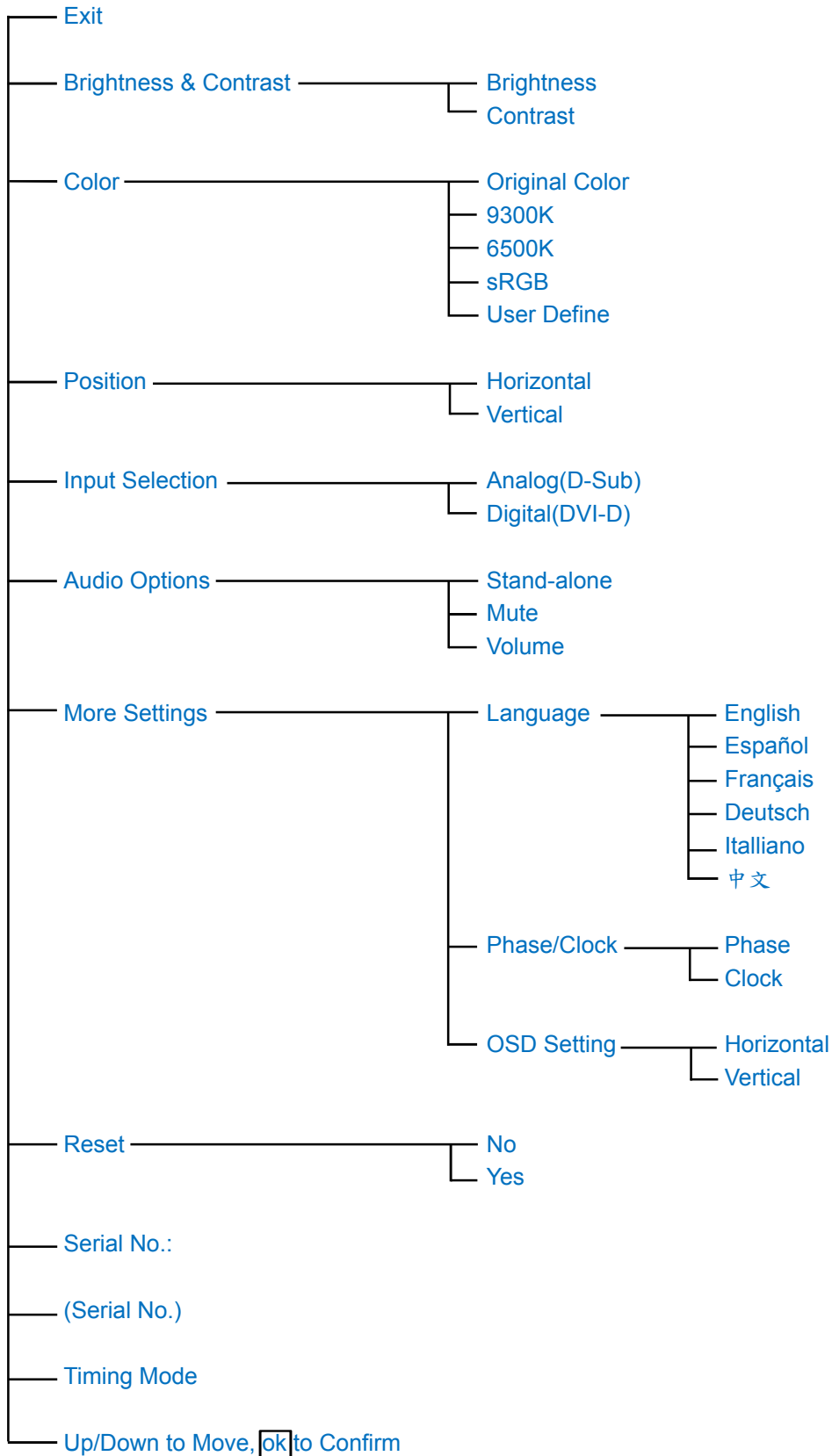

Note: sRGB is a standard for ensuring correct exchange of colors between different devices (e.g. digital cameras, monitors, printers, scanners, etc.)

Using a standard unified color space, sRGB will help represent pictures taken by an sRGB

compatible device correctly on your sRGB enabled Philips monitors. In that way, the colors are calibrated and you can rely on the correctness of the colors shown on your screen.

Important with the use of sRGB is that the brightness and contrast of your monitor is fixed to a predefined setting as well as the color gamut. Therefore it is important to select the sRGB setting in the monitor's OSD.

To do so, open the OSD by pressing the OK button on the side of your monitor. Move the down button to go to Color and press OK again. Use the right button to go to sRGB. Then move the down button and press OK again to exit the OSD.

After this, please do not change the brightness or contrast setting of your monitor. If you change either of these, the monitor will exit the sRGB mode and go to a color temperature setting of 6500K.

[RETURN TO TOP OF THE PAGE](#)

Customer Care & Warranty

PLEASE SELECT YOUR COUNTRY/AREA TO REVIEW DETAILS OF YOUR WARRANTY COVERAGE

WESTERN EUROPE: Austria • Belgium • Cyprus • Denmark • France • Germany • Greece • Finland • Ireland • Italy • Luxembourg • the Netherlands • Norway • Portugal • Sweden • Switzerland • Spain • United Kingdom

EASTERN EUROPE: Czech Republic • Hungary • Poland • Russia • Slovakia • Slovenia • Turkey

LATIN AMERICA: Antilles • Argentina • Brasil • Chile • Colombia • Mexico • Paraguay • Peru • Uruguay • Venezuela

NORTH AMERICA: Canada • USA

PACIFIC: Australia • New Zealand

ASIA: Bangladesh • China • Hong Kong • India • Indonesia • Japan • Korea • Malaysia • Pakistan • Philippines • Singapore • Taiwan • Thailand

AFRICA: Morocco • South Africa

MIDDLE EAST: Dubai • Egypt

Your Philips F1rst Choice Warranty

Thank you for purchasing this Philips monitor.



All Philips monitors are designed and manufactured to high standards and deliver high-quality performance, ease of use and ease of installation. Should you encounter any difficulties while installing or using this product, please contact the Philips helpdesk directly to benefit from your Philips F1rst Choice Warranty. This three-year service warranty entitles you to a swap model on-site if your monitor turns out to be faulty or defective. Philips aims at a swap within 48 hours of your call being received.

What is covered?

The Philips F1rst Choice Warranty applies within Andorra, Austria, Belgium, Cyprus, Denmark, France, Germany, Greece, Finland, Ireland, Italy, Liechtenstein, Luxembourg, Monaco, the Netherlands, Norway, Portugal, Sweden, Switzerland, Spain and the United Kingdom and only for monitors originally designed, manufactured, approved and/or authorized for usage within these countries.

Warranty coverage begins as from the day you buy your monitor. *For three years thereafter*, your monitor will be swapped by at least an equivalent monitor in case of defects provided for under the warranty coverage.

The swap monitor remains yours and Philips keeps the defective/original monitor. For the swap monitor the warranty period remains equal to that of your original monitor, being 36 months as from the purchase date of your original monitor.

What is excluded?

The Philips F1rst Choice Warranty applies provided the product is handled properly for its intended use, in accordance with its operating instructions and upon presentation of the original invoice or cash receipt, indicating the date of purchase, dealer's name and model and production number of the product.

The Philips F1rst Choice Warranty may not apply if:

- The documents have been altered in any way or made illegible;
- The model or production number on the product has been altered, deleted, removed or made illegible;
- Repairs or product modifications and alterations have been executed by unauthorized service organizations or persons;
- Damage is caused by accidents including but not limited to lightning, water or fire, misuse or neglect;
- Reception problems caused by signal conditions or cable or antenna systems outside the unit;
- Defects caused by abuse or misuse of the monitor;
- Product requires modification or adaptation to enable it to comply with local or national technical standards, which apply in countries for which the product was not

originally designed, manufactured, approved and/or authorized. Therefore always check whether a product can be used in a specific country.

- Note that products that are not originally designed, manufactured, approved and/or authorized for usage within the Philips F1rst Choice countries, do not apply to the Philips F1rst Choice Warranty. In these cases the Philips global warranty terms are valid.

Just a click away

In case of any problems, we advise you to read the operating instructions carefully or go to the www.philips.com/support website for additional support.

Just a phone call away

In order to avoid unnecessary inconvenience, we advise you to read the operating instructions carefully or go to the www.philips.com/support website for additional support before contacting the Philips helpdesk.

To solve your problem quickly, please prepare the following details before contacting the Philips helpdesk:

- Philips type number
- Philips serial number
- Purchase date (copy of purchase may be required)
- PC environment Processor:
 - 286/386/486/Pentium Pro/Internal memory
 - Operating system (Windows, DOS, OS/2, Apple Macintosh)
 - Fax/Modem/Internet program?
- Other cards installed

Having the following information available will also help speed up the process:

- Your proof of purchase indicating: date of purchase, dealer name, model and product serial number.
- The full address to which the faulty monitor has to be collected and the swap model should be delivered.

Philips' customer help desks are located worldwide. Click here to access the [F1rst Choice Contact Information](#).

Or you can reach us via:

Website: <http://www.philips.com/support>

F1rst Choice Contact Information

| Country | Telephone number | Tariff |
|------------------------|-------------------------|--------------------------|
| Austria | 0820 901115 | € 0.20 |
| Belgium | 070 253 010 | € 0.17 |
| Cyprus | 800 92256 | Free of Charge |
| Denmark | 3525 8761 | Local call tariff |
| Finland | 09 2290 1908 | Local call tariff |
| France | 08 9165 0006 | € 0.23 |
| Germany | 0180 5 007 532 | € 0.12 |
| Greece | 00800 3122 1223 | Local call tariff |
| Ireland | 01 601 1161 | Local call tariff |
| Italy | 199 404 042 | € 0.25 |
| Luxembourg | 26 84 30 00 | Local call tariff |
| The Netherlands | 0900 0400 063 | € 0.20 |
| Norway | 2270 8250 | Local call tariff |
| Portugal | 2 1359 1440 | Local call tariff |
| Spain | 902 888 785 | € 0.15 |
| Sweden | 08 632 0016 | Local call tariff |
| Switzerland | 02 2310 2116 | Local call tariff |
| United Kingdom | 0906 1010 017 | £0.15 |

Your Guarantee in Central and Eastern Europe

Dear Customer,

Thank you for purchasing this Philips product, which has been designed and manufactured to the highest quality standards. If, unfortunately, something should go wrong with this product Philips guarantees free of charge labor and replacement parts during a period of 36 months from date of purchase.

What is covered?

This Philips Guarantee in Central and Eastern Europe applies within Czech Republic, Hungary, Slovakia, Slovenia, Poland, Russia and Turkey and only for monitors originally designed, manufactured, approved and/or authorized for usage within these countries.

Warranty coverage begins as from the day you buy your monitor. *For 3 years thereafter, your monitor will be serviced in case of defects provided for under the warranty coverage.*

What is excluded?

The Philips guarantee applies provided the product is handled properly for its intended use, in accordance with its operating instructions and upon presentation of the original invoice or cash receipt, indicating the date of purchase, dealer's name and model and production number of the product.

The Philips guarantee may not apply if:

- the documents have been altered in any way or made illegible;
- the model or production number on the product has been altered, deleted, removed or made illegible;
- repairs or product modifications and alterations have been executed by unauthorized service organizations or persons;
- damage is caused by accidents including but not limited to lightning, water or fire, misuse or neglect.
- Reception problems caused by signal conditions or cable or antenna systems outside the unit;
- Defects caused by abuse or misuse of the monitor;
- Product requires modification or adaptation to enable it to comply with local or national technical standards, which apply in countries for which the product was not originally designed, manufactured, approved and/or authorized. Therefore always check whether a product can be used in a specific country.

Please note that the product is not defective under this guarantee in the case where modifications become necessary in order for the product to comply with local or national technical standards which apply in countries for which the product was not originally designed and/or manufactured. Therefore always check whether a product can be used in a specific country.

[Just a click away](#)

In case of any problems, we advise you to read the operating instructions carefully or go to the www.philips.com/support website for additional support.

Just a phone call away

In order to avoid unnecessary inconvenience, we advise you to read the operating instructions carefully before contacting our dealers or Information Centers

In case your Philips product is not working correctly or is defective, please contact your Philips dealer or directly the **Philips Service and Consumer Information Centers**

Website: <http://www.philips.com/support>

Consumer Information Centers

Antilles • Argentina • Astline • Australia • Bangladesh • Bosnia & Herzegovina • Brasil • Canada • Chile • China • Colombia • Belarus • Bulgaria • Croatia • Czech Republic • Estonia • Dubai • Hong Kong • Hungary • India • Indonesia • Korea • Latvia • Lithuania • Macedonia • Malaysia • Mexico • Morocco • New Zealand • Pakistan • Paraguay • Peru • Philippines • Poland • Romania • Russia • Serbia & Montenegro • Singapore • Slovakia • Slovenia • South Africa • Taiwan • Thailand • Turkey • Ukraine • Uruguay • Venezuela

Eastern Europe

BELARUS

**Technical Center of JV IBA
M. Bogdanovich str. 155
BY - 220040 Minsk
Tel: +375 17 217 33 86**

ASTLINE

**Petrus Brovky str. 17-101
BY - 220072 Minsk
Tel: +375 17 284 02 03**

BULGARIA

**LAN Service
140, Mimi Balkanska Str.
Office center Translog
1540 Sofia, Bulgaria
Tel: +359 2 960 2360
Email: office@lan-service.bg
www.lan-service.bg**

CZECH REPUBLIC

**Xpectrum
Lužná 591/4
CZ - 160 00 Praha 6 Tel: 800 100 697
Email: info@xpectrum.cz
www.xpectrum.cz**

BOSNIA & HERZEGOVINA

Megatrend d.o.o.
Bosnia & Herzegovina
Džemala Bijedica 2/11
BA - 7100 Sarajevo
Tel: +387 33 613 166
Email: info@megatrend.ba
www.megatrend.ba

CROATIA

Renoprom d.o.o.
Ljubljanska 4
HR - 10431 Sv. Nedjelja
Tel: +385 1 333 0999
Email: renoprom@renoprom.hr
www.renoprom.hr

ESTONIA

FUJITSU SERVICES OU
Akadeemia tee 21G
EE-12618 Tallinn
Tel: +372 6519900
www.ee.invia.fujitsu.com

HUNGARY

Profi Service
Hungary Külso-Váci út 123
HU - 1044 Budapest
Tel: +36 1 814 8080
Email: ugyfelszolgalat@psc.hu
www.psc.hu

LATVIA

ServiceNet LV
Jelgavas iela 36
LV - 1055 Riga,
Tel: +371 7460399
Email: serviss@servicenet.lv

MACEDONIA

AMC - Computers
kej Dimitar Vlahov bb
MK - 1000 Skopje
Tel: +389 2 3125097
www.amc.com.mk

LITHUANIA

ServiceNet LT
Gaiziunu G. 3
LT - 3009 KAUNAS
Tel: +370 7400088
Email: servisas@servicenet.lt
www.servicenet.lt

ROMANIA

Blue Ridge Int'l Computers SRL
115, Mihai Eminescu St., Sector 2
RO - 020074 Bucharest
Tel: +40 21 2101969
Email: tehnic@blueridge.ro
www.blueridge.ro

SERBIA & MONTENEGRO

Tehnicom Service d.o.o.
Bulevar Vojvode Misica 37B
YU - 11000 Belgrade
Tel: +381 11 30 60 881
Email: tehnicom-service@tehnicom.com
www.tehnicom-service.com

SLOVAKIA

Datalan Servisne Stredisko
Puchovska 8
SK - 831 06 Bratislava
Tel: +421 2 49207155
Email: servis@datalan.sk

SLOVENIA

PC HAND
Brezovce 10
SI - 1236 Trzin
Tel: +386 1 530 08 24
Email: servis@pchand.si

POLAND

Zolter
ul.Zytnia 1
PL - 05-500 Piaseczno
Tel: +48 22 7501766
Email: servmonitor@zolter.com.pl
www.zolter.com.pl

RUSSIA

Tel: +7 095 961-1111

Tel: 8-800-200-0880

Website: www.philips.ru

TURKEY

Türk Philips Ticaret A.S.

Yukari Dudullu Org.San.Bolgesi

2.Cadde No:22

34776-Umraniye/Istanbul

Tel: (0800)-261 33 02

UKRAINE

Comel

Shevchenko street 32

UA - 49030 Dnepropetrovsk

Tel: +380 562320045

www.csp-comel.com

Latin America

ANTILLES

Philips Antillana N.V.

Kaminda A.J.E. Kusters 4

Zeelandia, P.O. box 3523-3051

Willemstad, Curacao

Phone: (09)-4612799

Fax : (09)-4612772

ARGENTINA

Philips Antillana N.V.

Vedia 3892 Capital Federal

CP: 1430 Buenos Aires

Phone/Fax: (011)-4544 2047

BRASIL

Philips da Amazônia Ind. Elet. Ltda.

Rua Verbo Divino, 1400-São Paulo-SP

CEP-04719-002

Phones: 11 21210203 -São Paulo & 0800-701-0203-Other Regions without São Paulo City

CHILE

**Philips Chilena S.A.
Avenida Santa Maria 0760
P.O. box 2687 Santiago de Chile
Phone: (02)-730 2000
Fax : (02)-777 6730**

COLOMBIA

**Industrias Philips de Colombia
S.A.-Division de Servicio
CARRERA 15 Nr. 104-33
Bogota, Colombia
Phone:(01)-8000 111001 (toll free)
Fax : (01)-619-4300/619-4104**

MEXICO

**Consumer Information Centre
Norte 45 No.669
Col. Industrial Vallejo
C.P.02300, -Mexico, D.F.
Phone: (05)-3687788 / 9180050462
Fax : (05)-7284272**

PARAGUAY

**Av. Rca. Argentina 1780 c/Alfredo Seiferheld
P.O. Box 605
Phone: (595 21) 664 333
Fax: (595 21) 664 336
Customer Desk:
Phone: 009 800 54 1 0004**

PERU

**Philips Peruana S.A.
Customer Desk
Comandante Espinar 719
Casilla 1841
Limab18
Phone: (01)-2136200
Fax : (01)-2136276**

URUGUAY

**Rambla O'Higgins 5303 Montevideo
Uruguay
Phone: (598) 619 66 66
Fax: (598) 619 77 77
Customer Desk:
Phone: 0004054176**

VENEZUELA

**Industrias Venezolanas Philips S.A.
Apartado Postal 1167
Caracas 1010-A
Phone: (02) 2377575
Fax : (02) 2376420**

Canada

CANADA

**Philips Electronics Ltd.
281 Hillmount Road
Markham, Ontario L6C 2S3
Phone: (800) 479-6696**

Pacific

AUSTRALIA

**Philips Consumer Electronics
Consumer Care Center
Level 1, 65 Epping Rd
North Ryde NSW 2113
Phone: 1300 363 391
Fax : +61 2 9947 0063**

NEW ZEALAND

**Philips New Zealand Ltd.
Consumer Help Desk
2 Wagener Place, Mt.Albert
P.O. box 1041
Auckland
Phone: 0800 477 999 (toll free)
Fax : 0800 288 588**

Asia

BANGLADESH

**Philips Service Centre
100 Kazi Nazrul Islam
Avenue Kawran Bazar C/A
Dhaka-1215
Phone: (02)-812909
Fax : (02)-813062**

CHINA

**SHANGHAI
Rm 1007, Hongyun Building, No. 501 Wuning road,
200063 Shanghai P.R. China
Phone: 4008 800 008
Fax: 21-52710058**

HONG KONG

**Philips Electronics Hong Kong Limited
Consumer Service
Unit A, 10/F. Park Sun Building
103-107 Wo Yi Hop Road
Kwai Chung, N.T.
Hong Kong
Phone: (852)26199663
Fax: (852)24815847**

INDIA

**Phone: 91-20-712 2048 ext: 2765
Fax: 91-20-712 1558**

**BOMBAY
Philips India
Customer Relation Centre
Bandbox House
254-D Dr. A Besant Road, Worli
Bombay 400 025**

**CALCUTTA
Customer Relation Centre
7 justice Chandra Madhab Road
Calcutta 700 020**

**MADRAS
Customer Relation Centre
3, Haddows Road**

Madras 600 006

NEW DELHI
Customer Relation Centre
68, Shivaji Marg
New Dehli 110 015

INDONESIA

Philips Group of Companies in Indonesia
Consumer Information Centre
Jl.Buncit Raya Kav. 99-100
12510 Jakarta
Phone: (021)-7940040 ext: 2100
Fax : (021)-794 7511 / 794 7539

KOREA

Philips Consumer Service
Jeong An Bldg. 112-2
Banpo-dong, Seocho-Ku
Seoul, Korea
Customer Careline: 080-600-6600
Phone: (02) 709-1200
Fax : (02) 595-9688

MALAYSIA

After Market Solutions Sdn Bhd,
Philips Authorised Service Center,
Lot 6, Jalan 225, Section 51A,
46100 Petaling Jaya,
Selangor Darul Ehsan,
Malaysia.
Phone: (603)-7954 9691/7956 3695
Fax: (603)-7954 8504
Customer Careline: 1800-880-180

PAKISTAN

Philips Consumer Service
Mubarak manzil,
39, Garden Road, Saddar,
Karachi-74400
Tel: (9221) 2737411-16
Fax: (9221) 2721167
E-mail: care@philips.com
Website: www.philips.com.pk

PHILIPPINES

PHILIPS ELECTRONICS & LIGHTING, INC.
Consumer Electronics
48F PBCOM tower
6795 Ayala Avenue cor VA Rufino St.
Salcedo Village
1227 Makati City, PHILS
Phone: (02)-888 0572, Domestic Toll Free: 1-800-10-PHILIPS or 1-800-10-744 5477
Fax: (02)-888 0571

SINGAPORE

Accord Customer Care Solutions Ltd
Authorized Philips Service Center
Consumer Service
620A Lorong 1 Toa Rayoh
Singapore 319762
Tel: +65 6882 3999
Fax: +65 6250 8037

TAIWAN

Philips Taiwan Ltd.
Consumer Information Centre
13F, No. 3-1 Yuan Qu St., Nan Gang Dist.,
Taipei 115, Taiwan
Phone: 0800-231-099
Fax : (02)-3789-2641

THAILAND

Philips Electronics (Thailand) Ltd.
26-28th floor, Thai Summit Tower
1768 New Petchburi Road
Khwaeng Bangkok, Khet Huaykhwang
Bangkok 10320 Thailand
Tel: (66)2-6528652
E-mail: cic Thai@philips.com

Africa

MOROCCO

Philips Electronique Maroc
304, BD Mohamed V
Casablanca
Phone: (02)-302992
Fax : (02)-303446

SOUTH AFRICA

PHILIPS SA (PTY) LTD
Customer Care Center
195 Main Road
Martindale, Johannesburg
P.O. box 58088
Newville 2114
Telephone: +27 (0) 11 471 5194
Fax: +27 (0) 11 471 5123
E-mail: customercare.za@philips.com

Middle East

DUBAI

Philips Middle East B.V.
Consumer Information Centre
P.O.Box 7785
DUBAI
Phone: (04)-335 3666
Fax : (04)-335 3999

Your International Guarantee

Dear Customer,

Thank you for purchasing this Philips product which has been designed and manufactured to the highest quality standards.

If, unfortunately, something should go wrong with this product Philips guarantees free of charge labor and replacement parts irrespective of the country where it is repaired during a period of 12 months from date of purchase. This international Philips guarantee complements the existing national guarantee obligations to you of dealers and Philips in the country of purchase and does not affect your statutory rights as a customer.

The Philips guarantee applies provided the product is handled properly for its intended use, in accordance with its operating instructions and upon presentation of the original invoice or cash receipt, indicating the date of purchase, dealer's name and model and production number of the product.

The Philips guarantee may not apply if:

- the documents have been altered in any way or made illegible;
- the model or production number on the product has been altered, deleted, removed or made illegible;
- repairs or product modifications and alterations have been executed by unauthorized service organizations or persons;
- damage is caused by accidents including but not limited to lightning, water or fire, misuse or neglect.

Please note that the product is not defective under this guarantee in the case where modifications become necessary in order for the product to comply with local or national technical standards which apply in countries for which the product was not originally designed and/or manufactured. Therefore always check whether a product can be used in a specific country.

In case your Philips product is not working correctly or is defective, please contact your Philips dealer. In the event you require service whilst in another country a dealer address can be given to you by the Philips Consumer Help Desk in that country, the telephone and fax number of which can be found in the relevant part of this booklet.

In order to avoid unnecessary inconvenience, we advise you to read the operating instructions carefully before contacting your dealer. If you have questions which your dealer cannot answer or any related question please contact the [Philips Consumer Information Centers](#) or via:

Website: <http://www.philips.com>



LIMITED WARRANTY (Computer Monitor)

Three Years Free Labor/Three Years Free Service on Parts

**This product must be shipped in at your expense for service.*

WHO IS COVERED?

You must have proof of purchase to receive warranty service. A sales receipt or other document showing that you purchased the product is considered proof of purchase. Attach it to this owner's manual and keep both nearby.

WHAT IS COVERED?

Warranty coverage begins the day you buy your product. *For three years thereafter, all parts will be repaired or replaced, and labor is free. After three years from the day of purchase, you pay for the replacement or repair of all parts, and for all labor charges.*

All parts, including repaired and replaced parts, are covered only for the original warranty period. When the warranty on the original product expires, the warranty on all replaced and repaired products and parts also expires.

WHAT IS EXCLUDED?

Your warranty does not cover:

- labor charges for installation or setup of the product, adjustment of customer controls on the product, and installation or repair of antenna systems outside of the product.
- product repair and/or part replacement because of misuse, accident, unauthorized repair or other cause not within the control of Philips Consumer Electronics.
- reception problems caused by signal conditions or cable or antenna systems outside the unit.
- a product that requires modification or adaptation to enable it to operate in any country other than the country for which it was designed, manufactured, approved and/or authorized, or repair of products damaged by these modifications.
- incidental or consequential damages resulting from the product. (Some states do not allow the exclusion of incidental or consequential damages, so the above exclusion may not apply to you. This includes, but is not limited to, prerecorded material, whether copyrighted or not copyrighted.)
- the model or production number on the product has been altered, deleted, removed or made illegible.

Where IS SERVICE AVAILABLE?

Warranty service is available in all countries where the product is officially distributed by

Philips Consumer Electronics. In countries where Philips Consumer Electronics does not distribute the product, the local Philips service organization will attempt to provide service (although there may be a delay if the appropriate spare parts and technical manual(s) are not readily available).

Where CAN I GET MORE INFORMATION?

For more information, contact the Philips Customer Care Center by calling **(877) 835-1838 (U.S.A. customers only)** or **(919) 573-7855**.

Before Requesting Service...

Please check your owner's manual before requesting service. Adjustments of the controls discussed there may save you a service call.

TO GET WARRANTY SERVICE IN U.S.A., PUERTO RICO OR U.S. VIRGIN ISLANDS...

Contact the Philips Customer Care Center phone number listed below for product assistance and procedures for servicing:

Philips Customer Care Center

(877) 835-1838 or (919) 573-7855

(In U.S.A., Puerto Rico and U.S. Virgin Islands, all implied warranties, including implied warranties of merchantability and fitness for a particular purpose, are limited in duration to the duration of this express warranty. But, because some states do not allow limitations on how long an implied warranty may last, this limitation may not apply to you.)

REMEMBER... Please record the model and serial numbers found on the product below.

MODEL # _____

SERIAL # _____

This warranty gives you specific legal rights. You may have other rights which vary from state/province to state/province.

Before contacting Philips, please prepare the following details so we can solve your problem quickly.

- Philips type number
- Philips serial number
- Purchase date (copy of purchase may be required)
- PC environment Processor:

- 286/386/486/Pentium Pro/Internal memory

- Operating system (Windows, DOS, OS/2, Apple Macintosh)
- Fax/Modem/Internet program?

- Other cards installed
Having the following information available will also help speed up the process:
- Your proof of purchase indicating: date of purchase, dealer name, model and product serial number.
- The full address to which the swap model should be delivered.

Just a phone call away

Philips' customer help desks are located worldwide. Within the U.S. you can contact Philips customer care Monday-Friday from 8:00 AM-9:00 PM Eastern Time (ET) and on Saturdays from 10:00 AM-5:00 PM ET hrs by using one of the contact phone numbers.

For more information on this and more great Philips products visit our website at:

Website: <http://www.philips.com>

Glossary

A B C D E F G H I J K L M N O P Q R S T U V W X Y Z

A

Active matrix

This is a kind of liquid crystal display structure in which switching transistors are attached to each pixel to control the on/off voltage. It produces a brighter and sharper display with a broader viewing angle than a passive matrix display. Also refer to TFT (thin film transistor).

Amorphous silicon (a-Si)

A semiconductor material that is used to make the thin film transistors (TFTs) layer of an active matrix LCD.

Aspect ratio

The width-to-height ratio of the active area of a display. In general, most monitors have an aspect ratio of 4:3 or 5:4. Wide monitors or TVs have an aspect ratio of 16:9 or 16:10.

[RETURN TO TOP OF THE PAGE](#)

B

Brightness

The dimension of color that is referred to an achromatic scale, ranging from black to white, also called lightness or luminous reflectance. Because of confusion with saturation, the use of this term should be discouraged.

[RETURN TO TOP OF THE PAGE](#)

C

CCFL(cold cathode fluorescent light)

These are the fluorescent light tubes providing the light for the LCD module. These tubes are generally very thin, approximately 2 mm in diameter.

Chromaticity

That part of color specification, which does not involve illuminance. Chromaticity is two-dimensional and specified by pairs of numbers such as dominant wavelength and purity.

CIE (Commission International de l'Eclairage)

The International Commission on Illumination, the primary international organization concerned with color and color measurement.

Color temperature

A measurement of the color of light radiated by an object while it is being heated. This measurement is expressed in terms of absolute scale, (degrees Kelvin). Lower Kelvin temperatures such as 2400° K are red; higher temperatures such as 9300° K are blue. Neutral temperature is white, at 6504° K. Philips monitors generally offers 9300° K, 6500° K, and user define.

Contrast

The luminance variation between light and dark areas in an image.

Contrast ratio

The ratio of luminance between the brightest white pattern and the darkest black pattern.

RETURN TO TOP OF THE PAGE

D

Dual Input

Dual input provides connectors to accommodate input of both analog VGA and digital DVI signals.

D-SUB

A VGA Analog input connector. Your monitor comes with a D-Sub cable.

Digital Visual Interface (DVI)

The Digital Visual Interface (DVI) specification provides a high-speed digital connection for visual data types that is display technology independent. The interface is primarily focused at providing a connection between a computer and its display device. The DVI specification meets the needs of all segments of the PC industry (workstation, desktop, laptop, etc.) and will enable these different segments to unite around one monitor interface specification.

The DVI interface enables:

1. Reduce signal loss and video noise in signal due to less signal conversion.
2. Independent from display technology, and can be used on LCD, Plasma, LCOS, etc.
3. Plug and play through hot plug detection, EDID and DDC2B.
4. Digital and Analog support in a single connector (DVI-I only).

[RETURN TO TOP OF THE PAGE](#)

E

Embedded Power Supply

An embedded power supply is a power adaptor built into the body of a display device that replaces a bulky external power adaptor.

Energy Star Computers Program

An energy conservation program launched by the US Environmental Protection Agency (EPA), promotes the manufacture and marketing of energy-efficient office automation equipment. Companies joining this program, must be willing to commit themselves to manufacture one or more products capable of going into a low -power state (< 30 W) either after a period of inactivity, or after a predetermined time selected by the user.

[RETURN TO TOP OF THE PAGE](#)

F

FPadjust Program

The FP Adjust program generates alignment patterns which will help you adjust monitor settings such as CONTRAST, BRIGHTNESS, HORIZONTAL & VERTICAL POSITION, PHASE and CLOCK.

G

Gamma

Screen luminance as a function of video voltage approximately follows a mathematical power function of the input video signal, the exponent of which is called gamma.

Grayscale

An achromatic scale ranging from black through a series of successively lighter grays to white. Such a series may be made up of steps, which appear to be equally distant from one another. If the Analog/ Digital converter is 8 bit, then the monitor can display at most $2^8 = 256$ levels. For a color monitor, R.G.B. each color has 256 levels. Thus, total color can display is $256 \times 256 \times 256 = 16.7$ million.

H

HDCP

High-Bandwidth Digital Content Protection (HDCP) is a copyright protection system that is incorporated into the DVI connector. It helps stop unauthorized duplication of copyrighted content. HDCP allows you to play protected content media such as movies and concerts. It checks the signal to prevent piracy, allowing only legal copies of content to display.

Hue

The main attribute of a color that distinguishes it from other colors. For example, a color may have a green, yellow, or purple hue. Color defined as having hue are know as chromatic colors. White, black, and grays possess no hue.

I

IPS (In Plane Switching)

A technique of improving the viewing angle of an LCD where the liquid crystal molecules are switched in the plane of the LCD layer rather than vertical to it.

L

LCD (liquid crystal display)

A display composed of liquid crystal suspended between two transparent sheets. The display is composed thousands of pixels which can be turned on or off with electrical stimulation. Thus, colorful images/texts can be generated.

Liquid crystal

The compound found in liquid crystal displays. Liquid crystal reacts predictably when electrically stimulated. This makes it the ideal compound to turn LCD pixels "on" or "off." Liquid crystal is sometimes abbreviated as LC.

Luminance

A measure of the brightness or luminous intensity of light, usually expressed in units of Candelas per square meter (cd/m²) or foot Lamberts. 1 fL=3.426 cd/m².

[RETURN TO TOP OF THE PAGE](#)

N

Nit

A unit of luminance equal to 1 cd/m² or 0.292 ftL.

[RETURN TO TOP OF THE PAGE](#)

P

Pixel

PICTure Element; the smallest element on a computerized CRT or LCD image, and hence a display.

Polarizer

A light filter which only allows light waves of a certain rotation through. Polarized material with perpendicular filtering is used in LCDs to enclose the liquid crystal. The liquid crystal is then used as the medium which twists the light waves 90° in order to allow the light to pass through or not.

[RETURN TO TOP OF THE PAGE](#)

R

Refresh rate

The number of times per second the screen is refreshed or redrawn. This number is usually stated in Hz (Hertz) or cycles per second. A rate of 60 Hz is equal to 60 times per second.

Response Time

Response time is the period required for a liquid crystal cell to go from active (black) to inactive (white) and back to active (black) again. It is measured in milliseconds. Faster is better: Lower response time means faster transitions and, therefore, results in fewer visible image artifacts in the display of fast-moving images.

[RETURN TO TOP OF THE PAGE](#)

S

SmartControl

PC software for fine tuning display performance and settings. Philips offers users two choices for display setting adjustment. Either navigate the multilevel On Screen Display menu through buttons on the display itself or use the Philips SmartControl software to easily adjust the various display settings in a familiar way.

SmartImage Lite

Philips SmartImage Lite features with Philips LightFrame technology to enhance your front of screen performance depend by content type. It is changing brightness or contrast profiles to enrich color of image and sharpen text. No matter your application is on text processing or watching image or video, you can always get best viewing experience from Philips SmartImage Lite.

SmartManage

Built-in advanced firmware that delivers audio output from external audio devices including a portable tape, CD or MP3 player even when there is no video input.

SmartResponse

SmartResponse is exclusive Philips technology that adjusts response time to application requirements, delivering faster response times for gaming and videos or better color saturation for viewing photos and static images.

SmartTouch controls

SmartTouch controls are intelligent, ultra-responsive, touch sensitive icons that replace protruding buttons. Responding to your lightest touch, SmartTouch controls, for example, power up your monitor or brighten and sharpen your display with LightFrame™. When activated, SmartTouch icons glow to indicate that your commands have been implemented.

Stand-alone audio function

Built-in advanced firmware that delivers audio output from external audio devices including a portable tape, CD or MP3 player even when there is no video input.

sRGB

sRGB is a standard for ensuring correct exchange of colors between different devices (e.g. digital cameras, monitors, printers, scanners, etc.)

Using a standard unified color space, sRGB will help represent pictures taken by an sRGB compatible device correctly on your sRGB enabled Philips monitors. In that way, the colors are calibrated and you can rely on the correctness of the colors shown on your screen.

Important with the use of sRGB is that the brightness and contrast of your monitor is fixed to a predefined setting as well as the color gamut. Therefore it is important to select the sRGB setting in the monitor's OSD.

To do so, open the OSD by pressing the OK button on the side of your monitor. Move the down button to go to Color and press OK again. Use the right button to go to sRGB. Then move the down button and press OK again to exit the OSD.

After this, please do not change the brightness or contrast setting of your monitor. If you change either of these, the monitor will exit the sRGB mode and go to a color temperature setting of 6500K.

Other:

USB plug: An upstream and a downstream USB plug is provide for user's convenience.

[RETURN TO TOP OF THE PAGE](#)

T

TFT(thin film transistor)

Usually made from amorphous silicon (a-Si) and used as a switch to a charge storage device located below each sub-pixel on an active matrix LCD.

[RETURN TO TOP OF THE PAGE](#)

U

USB or Universal Serial Bus

The universal serial bus or USB is a standard protocol for linking PCs and peripherals. Because it delivers high speed at a low cost, USB has become the most popular method for connecting peripheral devices to a computer. A USB 2.0 port located on a monitor directly in the user's line of sight provides easy, high-speed connectivity for USB devices at a convenient location.

[RETURN TO TOP OF THE PAGE](#)

V

Vertical refresh rate

Expressed in Hz, it is the number of frames (complete pictures) written to the screen every second.

[RETURN TO TOP OF THE PAGE](#)

Download and Print

- Installing your LCD monitor driver
- Download and Printing Instructions
- Installing FPadjust Program

Installing Your LCD monitor driver

System requirements:

- PC running Windows 95, Windows® 98, Windows® 2000 , Windows® Me, Windows® XP, Vista or later
- Find your driver ".inf/.icm/.cat" at : lcd\pc\drivers

Read the "Readme.txt" file before installing.

This page provides an option to read the manual in .pdf format. PDF files can be downloaded into your hard disk, then viewed and printed with Acrobat Reader or through your browser.

If you do not have Adobe® Acrobat Reader installed, click on the link to install the application. [Adobe® Acrobat Reader for PC](#) / [Adobe® Acrobat Reader for Mac](#).

Download instructions:

To download the file:

1. Click-and-hold your mouse over the icon below. (Windows® 95/98/2000/Me/XP/Vista users right-click)

Download



200BW8.pdf

2. From the menu that appears, choose 'Save Link As...', 'Save Target As...' or 'Download Link to Disk'.

3. Choose where you would like to save the file; click 'Save' (if prompted to save as either 'text' or 'source', choose 'source').

Printing instructions:

To print the manual:

1. With the manual file open, follow your printer's instructions and print the pages you need.

Installing FPadjust Program

The FP Adjust program generates alignment patterns which will help you adjust monitor settings such as CONTRAST, BRIGHTNESS, HORIZONTAL & VERTICAL POSITION, PHASE and CLOCK.

System requirements:

- PC running Windows® 95, Windows® 98, Windows® 2000, Windows® Me, Windows® XP/Vista or later

To install FPadjust Program

- Click on the link or icon to install FPadjustment Program.
or
- Click-and-hold your mouse over the icon. (Win95/98/2000/Me/XP/Vista users right-click)

Download  [FP_setup4.3.exe](#)

- From the menu that appears, choose 'Save Link As...', 'Save Target As...' or 'Download Link to Disk'.
- Choose where you would like to save the file; click 'Save' (if prompted to save as either 'text' or 'source', choose 'source').
- Exit your browser and install the FPadjust Program.

Read the "FP_Readme04.txt" file before installing.